



Wood & Coal Burning Furnace Owners Manual

Models: 24AF, 24AG, 24AZ

TESTED TO UL 391

**All installations must be made in accordance with local and state codes
which may differ from this manual.**



USSC

UNITED STATES STOVE COMPANY
227 Industrial Park Road
P.O. Box 151
South Pittsburg, TN 37380



851224C

CHIMNEY INSTALLATION

Your new furnace must be installed into a "Class A" Chimney only. This type of chimney consists of a flue lined brick chimney, or an approved "Class A" all fuel factory built (prefabricated) type. Any other installation guarantees an immediate fire hazard.

Do not install the furnace into the same chimney serving other appliances.

When using 8" flue pipe, the chimney should have an 8" to 10" round flue liner or 9"x9" square liner.

The chimney should have a minimum height of 3' from the top of the chimney to the point at which it passes through the roof.

The top of the chimney must be at least 2' higher than the peak or the highest portion of the roof within 10' horizontally.

A chimney that rises within the house is better insulated than a chimney that is located outside the house and exposed to the weather, the north side of the house is the worst position.

Check manual for proper installation of flue pipe into chimney.

FURNACE INSTALLATION

Install your furnace as close to the chimney as possible with a minimum of elbows, no more than two and a flue pipe run of no more than 6 feet horizontally. Also, the flue pipe should contain a 1/2" rise per foot and NEVER be installed closer than 18" from combustibles.

WOOD BURNING: Install a manual flue pipe draft damper at a safe, convenient location between your furnace and chimney.

COAL BURNING: Install a barometric damper set at .05 Water Column.

AIR FLOW: Solid Fuel furnaces produce much hotter air than oil or gas fired appliances so all clearances are mandatory.

AIR DUCT INSTALLATION: This furnace provides a 12" round (113 sq. in.) opening, because of efficiency and general convenience.

United States Stove Company recommends a Parallel Furnace Installation with direct (ducted) feed or return air to your furnace. NOTE: Cold air duct intake must be at least 25% larger than hot air duct outlet.

FURNACE ASSEMBLY

U.S. Stove provides easy step by step pictures, therefore, the furnace assembly procedure should be understandable.

FIRING YOUR FURNACE

Start on a conservative basis. Your new furnace, when properly fired with hard dry wood will achieve approximately 6 to 8 hours of burn time per load of wood, much longer with coal. If the furnace is being fired hot constantly with full flames and only provides a 3 hour burn cycle, the furnace is being overfired. Possibly your heating requirements are too much for the size of furnace purchased. Certainly allowing your existing furnace to assist in extremely cold weather is no crime. Remember, your furnace can be damaged if fired continually at extremely high temperatures and this procedure will void your warranty.

CAUTION: OVERFIRING YOUR FURNACE VOIDS WARRANTY.

OVER FIRING

This generally occurs when the following procedures are not followed, ash door is open (even partially open), the feed door pressure relief flap is open, the feed door is open or the manual draft spinner is open. Open the ash and feed doors only when in attendance, never leave the furnace unattended when doors are open. This furnace has an automatic draft fan so use the manual draft with a specific purpose. Also, an overfilled ash drawer can cause grate warpage, keep ash drawer clean. Don't use furnace if distribution fan isn't functioning properly, and keep air filter clean. Draft fan opening should be set at 1/2" open as a point of start, depending on condition of fuel.

U. S. Stove recommends a very active fire at all times for maximum results, but only as instructed.

SOME HELPFUL HINTS

- Your furnace will hold logs approximately 2" shorter than the length of the firebox. Don't force in oversized logs.
 - Unsplit, dry logs will provide longer burn time than split logs.
 - Don't ever try to burn trash or garbage.
 - Keep flue pipe stack temperature between 300 and 400 degrees. This will reduce creosote build-up. A magnetic surface thermometer can be obtained from your dealer.
 - Weather is the most important determinant in how you operate your furnace (assuming you have dry wood).
 - The colder it is the stronger the draft, warm weather reduces draft. Set your draft fan rheostat and manual draft accordingly.
 - Open manual smoke damper only when starting the fire and when chimney draft is marginal.
 - Always place logs so air can flow between them.
 - Shake gently (up to 10 o'clock down to 8 o'clock) don't try to loose weight shaking down ashes!
 - Wood ash is useful as a fertilizer because it contains potassium, ashes also decrease the acidity of the soil. Coal ashes will provide good traction on ice or snow, otherwise they are useless.
 - Always store ashes in a metal container with a lid.
 - Ashes are a good thermal insulator and will keep enough oxygen away so embers will not burn out.
 - Never, never let ashes accumulate up to grate level, this will greatly reduce the life span of your grate.
 - Coal produces much more ash than wood.
 - Keep your chimney and flue pipe clean, check monthly.
 - Smoke detectors and fire extinguishers should always be a part of your equipment.
 - Never use chemicals or fluids such as gasoline, charcoal lighter, drain oil or kerosene to light a fire.
 - Oil the air fan motors yearly. They do not contain bearings, sleeves with felt. Therefore keeping fan air clean is more important than oiling.
 - Turn on your regular furnace once every month to keep it tuned up.
 - Always shut the furnace down gradually to prevent excessive stress on steel.
- WARPAGE OF STEEL IS COMMON, AGGRESSIVE BUT GENTLE FIRING CAN MINIMIZE WARPAGE.**
- There is no substitute for dry hard wood. Wood requires 6 months to a year to air dry to 25% moisture content or less.
 - Don't throw heavy, wet wood into your Jensen, it could crack the firebox and bricks.
 - Treat your furnace with the proper respect and it will reward you with much comfort, and a lifetime of central heat.

Welcome...

...to the world of solid fuel heating! Your new furnace has been designed and built with a high grade of materials and the strictest regard to quality.

Before you start installing your new furnace, take the time to read these installation and operating instructions. We have prepared them for your benefit to save time and provide some helpful knowledge on wood and coal burning.

Save the instructions for future use. It won't take long for you to realize the benefit of solid fuel heating, however, maintenance is the key to a long lasting relationship with your new furnace. These instructions can help you now as well as in the future.

Note: This owners manual is provided for Forced Air add on furnaces. United States Stove Company is constantly developing and improving its product line, therefore, we reserve the right to change specifications without notice.

Table Of Contents

General Rules	4
How It Works	5
Parts List	6-7
Installation Instructions	8-11
Assembly	12-16
Accessories	17
Wiring	18-23
Trouble Shooting	24
Notes	25-26
Warranty	27
How To Order Repair Parts	28

General Rules

Rules for the Safe Installation and Operation of Your Furnace...

Check local codes, the installation must comply with strict conformance in regard to clearances.

The Furnace must be installed on a noncombustible floor.

Connect the furnace to tile lined inside masonry chimney or approved insulated all fuel prefabricated chimney only.

Keep smoke pipe connection as short as possible, using a minimum 24 gauge pipe with a minimum 1/2" per foot rise from the flue collar to the chimney opening.

Be sure there is a sufficient supply of combustion air to the area where the furnace is to be located.

Do not over draft the furnace! It is designed to operate at .04 to .06 inches of water column and must be set with a draft gauge to maintain a steady draft.

Do not use flammable liquids for starting a fire.

Do not store fuel or combustibles near the furnace. Some areas of the furnace are hot and could cause an explosion and possible bodily or property damage.

Store all ashes in a metal container with a tight sealing lid and allow ashes to cool before disposing of them, possibly a week.

Familiarize yourself with the furnace's solid fuel burning characteristics before leaving unit unattended for long periods of time.

The loading door and ash door must be tightly closed during furnace operation to insure safety and efficiency.

CAUTION-

The furnace has hot surfaces. Keep Children Away. Do not touch during operation.

In the event of a chimney fire call the fire department, then be sure the furnace doors are closed tightly and the power to the unit is turned off.

The furnace is designed to burn air dried wood and coal at a predetermined firing rate. Over firing could result in damage to the heat exchanger and cause dangerous operation. Over firing occurs when the ash door is left open during operation or a highly volatile fuel, such as large amounts of small kindling, is used. Note: This action voids all warranty.

Follow a regular service and maintenance schedule of the furnace and chimney for efficient and safe operation.

Do not leave the ash door open when the fire is burning.

Do not let ashes build up closer than 2" to the grate.

With new steel, there is a small amount of oil or dirt on the metal. You may smell an odor. This is normal during the first operation. You should assemble the furnace out of doors and build a small fire in it to "burn off" this dirt and oil before installing the unit.

During the first few fires, heat may slightly warp the front and back panels. This is normal and will not hamper your unit's operation.

DO NOT CONNECT THIS UNIT TO A CHIMNEY FLUE SERVING ANOTHER APPLIANCE

BURN WOOD OR COAL ONLY IN MODEL 24AF. DO NOT MIX OTHER THAN THE USE OF WOOD TO START A COAL FIRE.

DANGER - Risk of Fire or Explosion: Do not burn garbage, gasoline, drain oil or other flammable liquids.

WARNING - Risk of Fire:

Do not operate with flue draft exceeding 6 inches water column.

Do not operate with fuel loading or ash removal doors open.

Do not store fuel or other combustible material within marked installation clearances.

Inspect and clean flues and chimney regularly.

This Furnace Must Be Installed By A Qualified Installer.

How...

How Your New Furnace Works

Unlike conventional heating (gas, oil, electric), wood or coal heating requires more user attention. Your furnace, with its automatic combustion air blower, alleviates the constant need for adjusting the burning rate common to other units on the market. The fire, however, must be started and subsequent fuel added by the user.

Conventional heating system produce heat only when the thermostat calls for heat. This way of heating is inefficient and often leaves part of the home either too hot or too cold. Your furnace is designed to deliver heat as long as there is a fire in it. The fire intensity is regulated by the room thermostat, high or low, the fire continues to produce heat. This heat is continuously distributed throughout the home by a distribution blower. This constant supply of heat is uniform and prevents drafts.

WARNING

Note: Improper firing. Wood or coal over firing occurs when the ash door is left open during operation or a highly volatile fuel is used. Coal that exceeds the fire brick line will cause overfiring...this type of operation will immediately void any warranty.

Parts

KEY	PART #	DESCRIPTION	QTY.
1	69072	FIREBOXWELDMENT	1
2	C97999	WATERCOILCOVERGASKET	1
3	24220	INSIDECOVERPLATE	1
N/S	C23799	12 x 3/4" TEKS SCREW	3
N/S	83236	1/4-20 x 3/4" HX SCREW	4
4	25085	FEEDDOOR	1
N/S	88033	3/8" ROPE GASKET (FEED DOOR)	4.25 FT.
N/S	C21390	7/32 x 1 ROLL PIN (FEED DOOR)	2
5	24482	PRESSUREFLAP	1
N/S	88075	3/4 FLAT ROPE GASKET	1 FT.
N/S	C21390	7/32 x 1 ROLL PIN (PRESSURE FLAP)	2
6	69077	FEEDDOORHANDLEASSY.	1
7	83379	1/4-20 x 1 BOLT	1
8	83261	1/4-20 LOCK NUT	1
9	24485	ASHDOOR	1
N/S	88033	3/8 ROPE GASKET	2.29 FT.
10	24486	ASHDOORHANDLE	1
N/S	C21390	7/32 x 1 ROLL PIN (ASHDOOR)	2
11	83379	1/4-20 x 1 BOLT	1
12	83261	1/4-20 LOCK NUT	1
13	24382	SPINDAMPER	1
14	83471	5/16-18 x 1-3/4" CARR. BOLT	1
15	83423	5/16-18 HEX LOCK NUT	1
16	69068	ASHDRAWERASSY.	1
17	24501	SMOKECURTAIN	1
18	83445	1/4-20 x 1-1/4" BOLT	2
19	83261	1/4-20 LOCK NUT	2
20	23787	SMOKEDOORCLIP	2
21	89799	STUBCOLLAR	1
22	24528	DAMPERROD	1
N/S	83874	1/8 DIA. x 1-1/2" COTTER PIN	1
23	69080	CONTROLCENTER	1
24	69097	FORCED DRAFT BLOWER ASSY.	1
25	80129	THERMOSTAT	1
26	89574	SPRINGHANDLE (DAMPERROD, SHAKER)	2
27	89849	HOOKSPRINGHANDLE (FEED, ASHDOOR)	2
28	69082	JUNCTIONBOXASSY.	1
29	69069	SHAKERGRATEHANDLE	1
30	40369	SHAKERGRATEFRAME	2
31	40349	SHAKERGRATE	2
32	40366	FIREBOXLINER	2
33	24496	FRONTHEATPLATE	1
34	24487	FURNACEHEATPLATE	1
35	89066	FIREBRICK	10
36	24488	CABINETTOP	1
37	24489	CABINETRIGHTSIDE	1
38	24490	CABINETLEFTSIDE	1
39	C60456	1050 CFM DISTRIBUTION BLOWER	1

FOR MODEL(S): 24AF

N/S=NOT SHOWN

Parts

FOR MODEL(S): 24AG, 24AZ

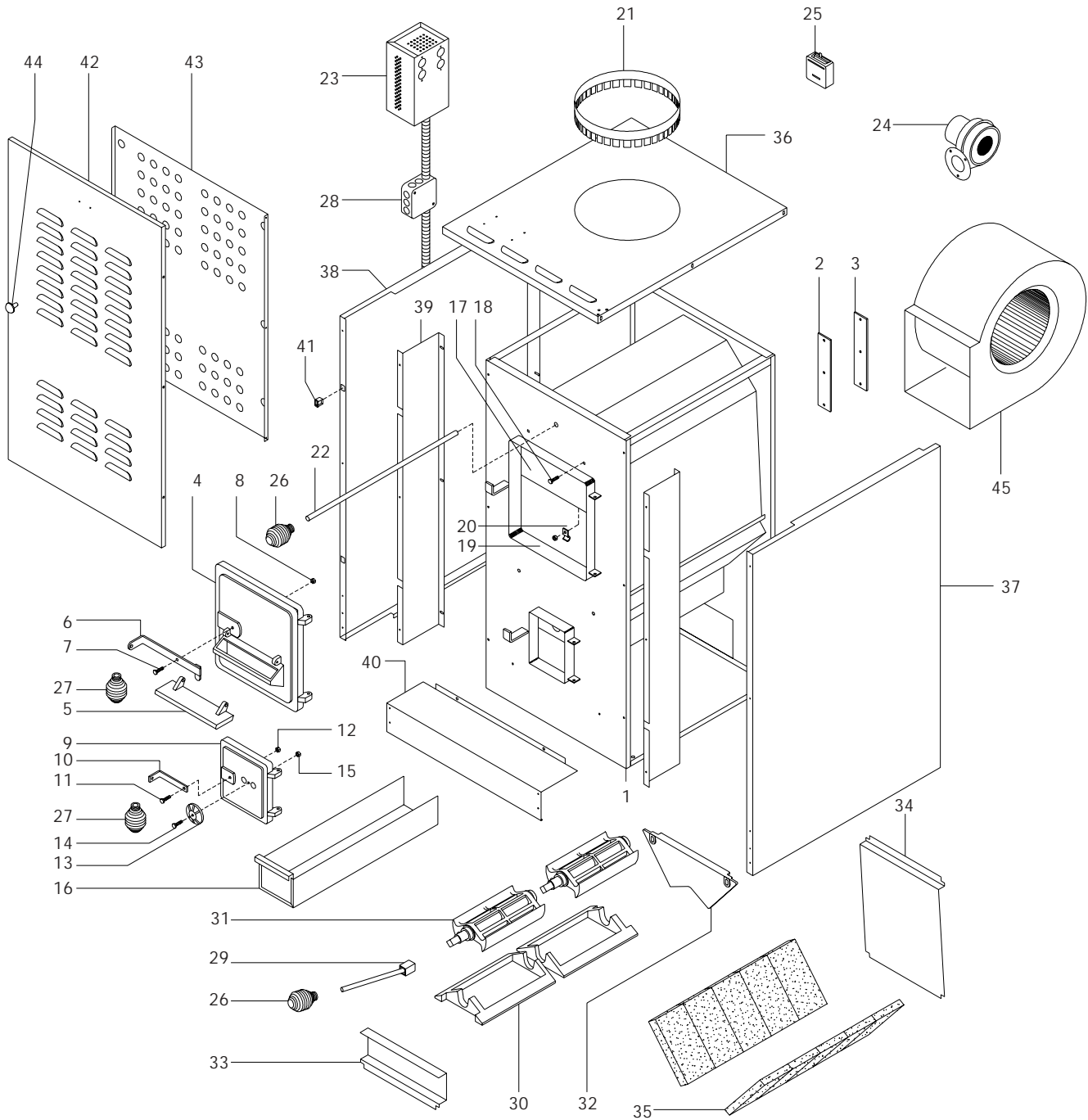

Parts

KEY	PART #	DESCRIPTION	QTY.
1	69315	FIREBOXWELDMENT	1
2	C97999	WATER COIL COVER GASKET	1
3	24220	INSIDE COVER PLATE	1
NS	C23799	12 x 3/4" TEKS SCREW	3
NS	83236	1/4-20 x 3/4" HX SCREW	4
4	25085	FEED DOOR	1
NS	88033	3/8" ROPE GASKET (FEED DOOR)	4.25 FT.
NS	C21390	7/32 x 1 ROLL PIN (FEED DOOR)	2
5	24482	PRESSURE FLAP	1
NS	88075	3/4 FLAT ROPE GASKET	1 FT.
NS	C21390	7/32 x 1 ROLL PIN (PRESSURE FLAP)	2
6	69326B	FEED DOOR HANDLE ASSY.	1
7	83379	1/4-20 x 1 BOLT	1
8	83261	1/4-20 LOCK NUT	1
9	24485	ASH DOOR	1
NS	88033	3/8 ROPE GASKET	2.29 FT.
10	25047B	ASH DOOR HANDLE	1
NS	C21390	7/32 x 1 ROLL PIN (ASH DOOR)	2
11	83379	1/4-20 x 1 BOLT	1
12	83261	1/4-20 LOCK NUT	1
13	24382	SPIN DAMPER	1
14	83471	5/16-18 x 1-3/4" CARR. BOLT	1
15	83423	5/16-18 HEX LOCK NUT	1
16	69068	ASH DRAWER ASSY.	1
17	24501	SMOKE CURTAIN	1
18	83445	1/4-20 x 1-1/4" BOLT	2
19	83261	1/4-20 LOCK NUT	2
20	23787	SMOKE DOOR CLIP	2
21	89799	STUB COLLAR	1
22	24528	DAMPER ROD	1
NS	83874	1/8 DIA. x 1-1/2" COTTER PIN	1
23	69321G	CONTROL CENTER	1
**	69323	CONTROL CENTER (STAINLESS STEEL)	1
24	69097	FORCED DRAFT BLOWER ASSY.	1
25	80129	THERMOSTAT	1
26	89574	SPRING HANDLE (DAMPER ROD, SHAKER)	2
27	89849	HOOK SPRING HANDLE (FEED, ASH DOOR)	2
28	69082	JUNCTION BOX ASSY.	1
29	69069	SHAKER GRATE HANDLE	1
30	40369	SHAKER GRATE FRAME	2
31	40349	SHAKER GRATE	2
32	40366	FIREBOX LINER	2
33	24496	FRONT HEAT PLATE	1
34	24487	FURNACE HEAT PLATE	1
35	89066	FIREBRICK	10
36	25014G	CABINET TOP	1
**	25015	CABINET TOP (STAINLESS STEEL)	1
37	25016G	CABINET RIGHT SIDE	1
**	25017	CABINET RIGHT SIDE (STAINLESS STEEL)	1
38	25018G	CABINET LEFT SIDE	1
**	25019	CABINET LEFT SIDE (STAINLESS STEEL)	1
39	25025B	SIDE FILLER	2
40	25020G	BOTTOM FRONT	1
**	25021	BOTTOM FRONT (STAINLESS STEEL)	1
41	891049	CATCH	2
NS	891048	BALL STRIKE	2
42	25022G	CABINET DOOR	1
**	25023	CABINET DOOR (STAINLESS STEEL)	1
NS	69318B	TOP CABINET DOOR HINGE	1
NS	69319B	TOP CABINET DOOR HINGE	1
NS	851405	ASHLEY SCRIPT LOGO	1
43	25024B	LINER, CABINET DOOR	1
44	89943	DOOR KNOB	1
45	C60456	1050 CFM DISTRIBUTION BLOWER	1

FOR MODEL(S): 24AG, 24AZ

N/S = NOT SHOWN ** = USED ON 24AZ

Installation

Furnace location

Before you start!

It is very important you check with your dealer, local fire department, or building inspector. They will be able to inform you of any state or local codes pertaining to the location and installation of your furnace.

The ideal location for your furnace is centrally located in the basement. This allows for an even heat distribution by having all the duct work approximately the same length. Ideal locations cannot always be used for one reason or another, therefore, let's look at some alternatives.

If your home does not have a basement, but a utility room or garage, make sure there is enough space to maintain the required clearances stated on the label located on the furnace. Also, read about combustion air.

INSTALLATION #1

With this installation, a back draft damper (optional) is inserted into the heat run before the plenum of the existing furnace to prevent air from the existing furnace to blow back into the furnace when it is not in use. When a back damper is employed, it should be located as close to the existing furnace plenum as practical.

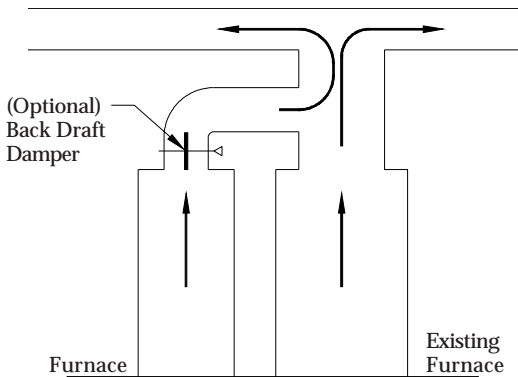

Chimney location is also critical. The furnace must be placed as close as possible to the chimney. You want the chimney connector (smoke pipe) to have a minimum of elbows, two (2) or less. Also, the chimney connector should not have to run more than six (6) feet to the chimney.

CAUTION: The warm-air supply outlet of the Furnace should not be connected to the cold-air return inlet of the central furnace because a possibility exists of components of the central furnace overheating and causing the central furnace to operate other than as intended.

After installation, be sure the measured external static pressure of the central and Furnace is not greater than those marked on the nameplates.

INSTALLATION #2

Extending the hot air duct from the furnace into the existing plenum will help direct the flow of air from the furnace as well as the flow in the existing furnace. Ducting entering the existing plenum at an angle (approximately 45 degrees) will facilitate air flow from the furnace while diverting air from the existing furnace.

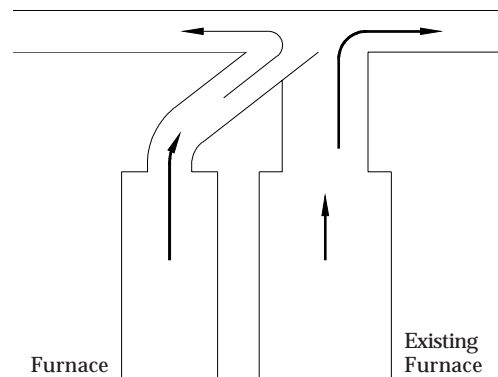

INSTALLATION #3

The baffle on this system should be made the full width of the furnace plenum in order to properly direct the air into the distribution ducts.

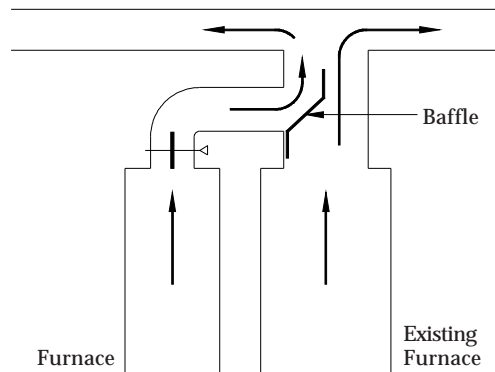

Your furnace is designed to be added on to existing duct work and operate either with or without another heat source such as a gas furnace. The following diagrams illustrate acceptable ways of ducting your furnace.

Clearance to Combustible Materials

Your Furnace has been tested to determine the SAFE clearances to combustible material. The clearances are printed on the label located on the back of the furnace. The chart on this page also states these minimum clearances. Make sure you follow these when choosing your furnace location.

Clearance to Combustibles	
Furnace to back wall	30"
Furnace to side wall	12"
Pipe to back wall	18"
Pipe to side wall	18"
Furnace to ceiling	30"
Ductwork to ceiling	18-6-1"

Any hot air plenum connection to a furnace must be constructed of metal.

NOTE: INSTALL ONLY ON A NON-COMBUSTIBLE FLOOR.

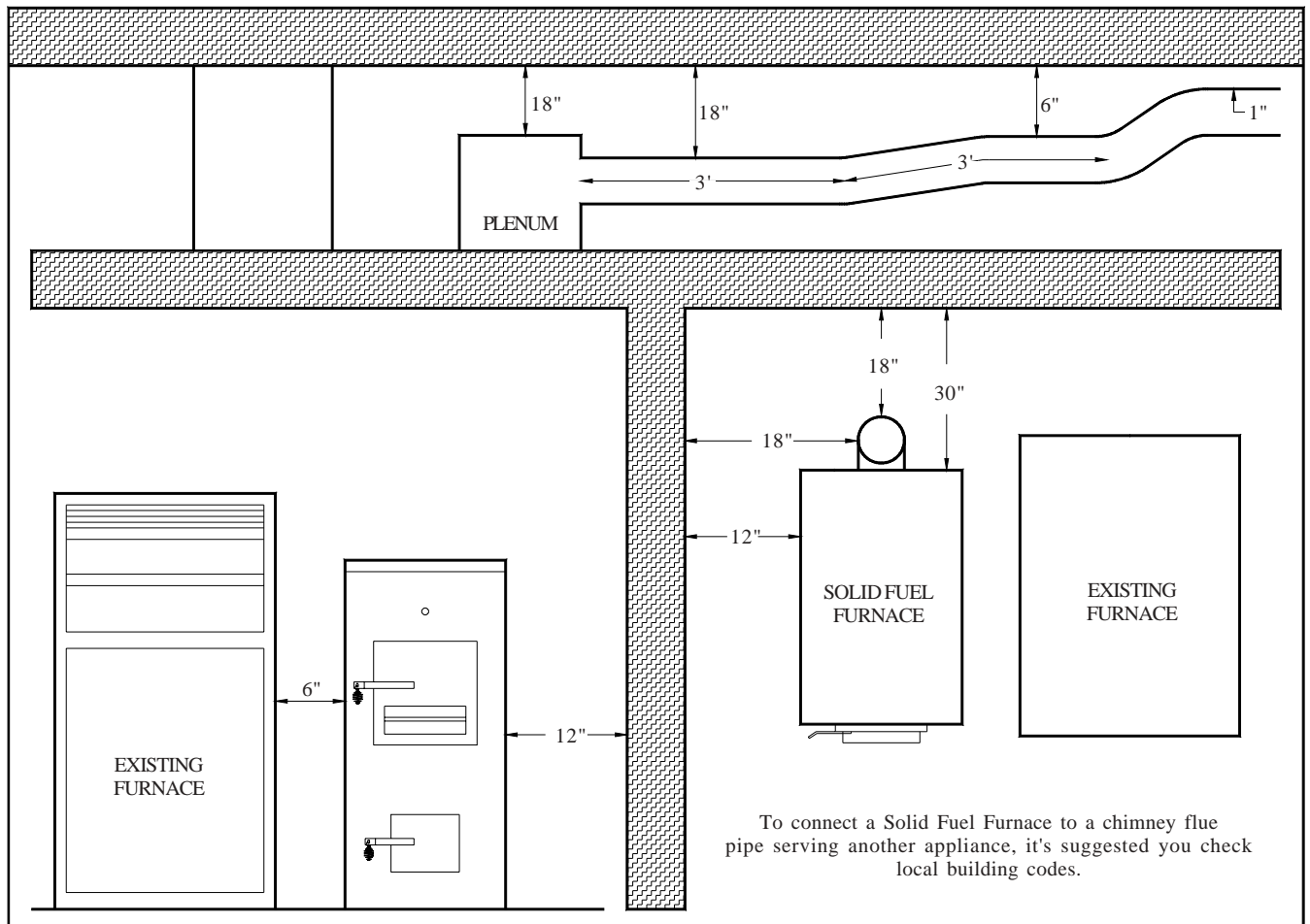

FLUE RECOMMENDATIONS

The termination cap should be designed to inhibit downdrafting without restricting the exhaust discharge.

The flue termination should be at least 3' above the roof line.

Chimney experts have determined that the flue termination should be at least 2' above the highest portion of the roof that is within a 10' radius.

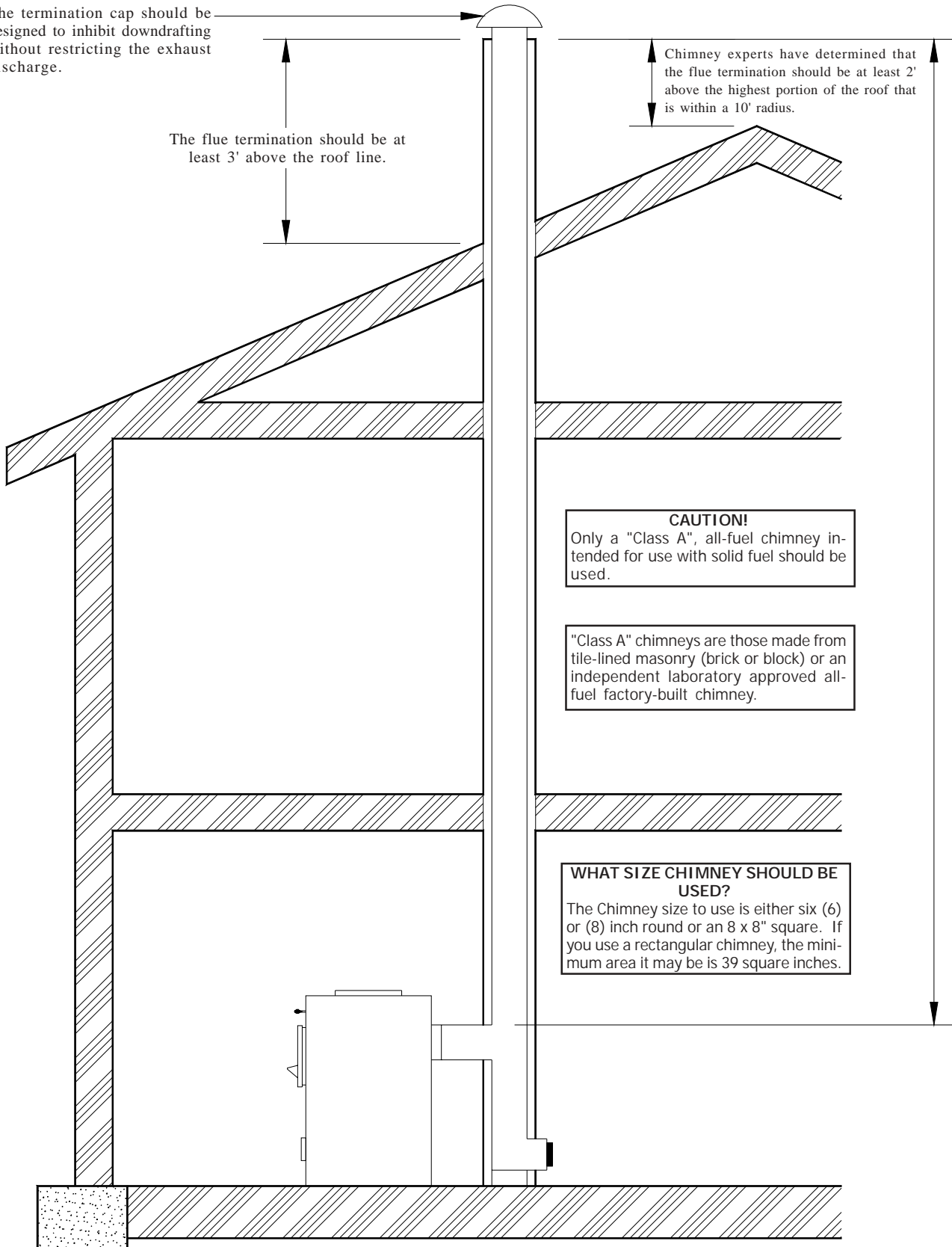

CAUTION!
Only a "Class A", all-fuel chimney intended for use with solid fuel should be used.

"Class A" chimneys are those made from tile-lined masonry (brick or block) or an independent laboratory approved all-fuel factory-built chimney.

WHAT SIZE CHIMNEY SHOULD BE USED?
The Chimney size to use is either six (6) or (8) inch round or an 8 x 8" square. If you use a rectangular chimney, the minimum area it may be is 39 square inches.

CHIMNEY INSTALLATION

With the chimney being the most important part to your installation, great care should be given to its design.

MASONRY CHIMNEYS

If your intention is to use an existing masonry chimney, check first with your local building official to see if this is acceptable.

An older chimney, in need of repair, is the GREATEST fire hazard in any installation.

STOVE PIPE (FLUE PIPE) CONNECTION

The flue pipe you should use is 6" or 8" 24 gauge or heavier steel pipe.

When installing the flue pipe, make sure all joints are secured with at least three (3) sheet metal screws. This includes the connection to the flue collar of the furnace. For added protection, use some high temperature furnace cement to seal each joint.

The stove pipe should slope upward to the chimney at a rate of 1/2 inch per foot. Any horizontal runs of stove pipe should not exceed six (6) feet and it should be supported every four (4) feet. Note: Flue pipe should be attached inside the flue pipe collar to prevent creosote from running down onto electrical motors.

CONNECTION OF FLUE PIPE TO A MASONRY CHIMNEY

When connecting flue pipe to a masonry chimney, there are two ways to go:

1. The flue pipe itself can be cemented into the chimney or;
2. A thimble can be used which is cemented into the chimney, and the flue pipe fits into the thimble.

In each case, care must be taken. The outer masonry (brick or block) must be chipped away, and the inner liner must be pierced. The flue pipe or thimble is then inserted flush to the inside face of the tile liner. NOT ANY FURTHER!

Use furnace cement or mortar to seal this connection. When connecting the flue pipe, make sure the attachment is secure enough so down draft or "puffs" do not dislodge it.

FACTORY-BUILT OR METAL CHIMNEYS

If your home has an existing metal chimney, the same rules apply as with masonry chimneys. One thing to be especially aware of is that "Class B" chimneys are for gas appliances only, not solid fuel burners. If purchasing a new package, consult with the dealer. He will provide the necessary parts and instructions for installation.

INSTALLING A NEW CHIMNEY

When installing a new chimney, whether it be masonry or metal, if possible, it is recommended that it is placed within the house structure. These chimneys remain warmer and, in turn, radiate this warmth into the house. A chimney located outside the house is exposed to cold temperatures which encourages creosote build-up and poor chimney draft.

CONNECTING STOVE PIPE TO A METAL CHIMNEY

When using a metal chimney, part of the installation package should include a stove pipe connector. Follow the instructions provided with the chimney and its parts.

CHIMNEY DRAFT REGULATORS (OPTIONAL) BAROMETRIC DAMPER

These devices are used to help maintain adequate chimney draft automatically. They should be installed according to their instructions and set at .04 to .06 inches of water column.

MANUAL DAMPER

(RECOMMENDED FOR ADDED SAFETY)

These are used to control chimney draft manually and should be installed in a convenient place between furnace and chimney. In the event of a chimney fire, it should be closed reducing air to the chimney fire.

A combination of both barometric damper and manual damper may be used. If this is the case, install the manual damper between the barometric damper and the chimney.

VENTILATION FOR YOUR FURNACE

There are many appliances which require "make up" air to operate. However, with a combustion air draft fan, "make-up" air is not usually necessary with your wood furnace.

If your home is sealed exceptionally well, use a 3" or 4" diameter duct vented to the outside and terminating in the vicinity of the combustion air draft fan. Also, it is possible for your fans to draw in furnace smoke if there is only dead air in the area. Note: It's highly recommended that a cold air return system be utilized. Simply attach a 14" round to a filter box adapter and attach to cold air return. Also, a cold air return increases motor life.

NOTE: Your furnace may come partially pre-assembled, but in the case that it is not, follow the instructions below.

Prior to assembling, place the unit in the general vicinity of the installation. This should help minimize handling damage to the unit after assembly. Note: If your basement can't handle a height of 7' 8" you must lay the furnace on two, 2 x 4's to slide shrouds onto weldment. Then stand furnace up.

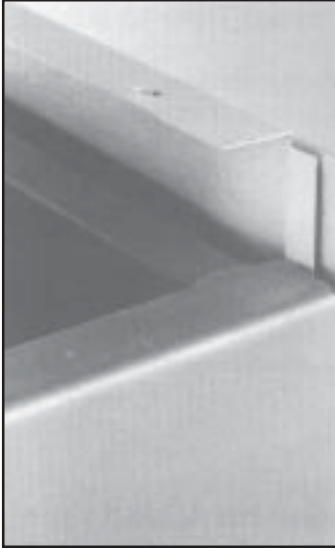

1. Unit side shrouds can be assembled by slipping the side shrouds into place from the top down. If they don't slide easily, open up the lip of the sides with a large screw driver then add a little oil. Sometimes a slight tapping with a block of wood and hammer may be required, but do not force. When properly installed, the electrical knock-outs will be at the top left side. NOTE: Should you wish to install a domestic hot water coil, it should be secured to the right side prior to assembly. Also, the rear cast iron baffle must be fastened prior to shroud installation.

NOTE: The furnace is partially prewired all that is required is the wiring of the distribution fan (see wiring diagram, page 18) and the wiring to wall the thermostat.

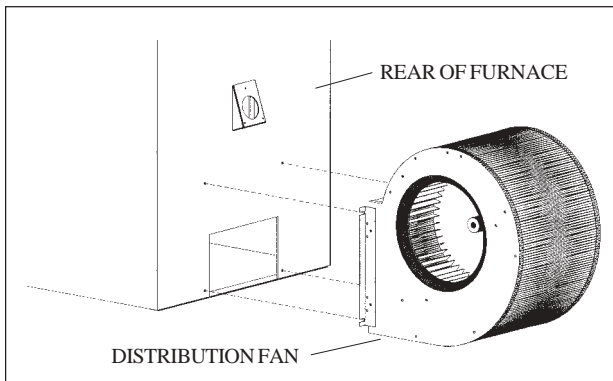

2. Attaching the distribution fan. First, remove the four (4) bolts from the rear of the unit. Secondly, slide the distribution fan up to the rear of the furnace, line up the (4) holes and reattach the bolts and tighten securely.

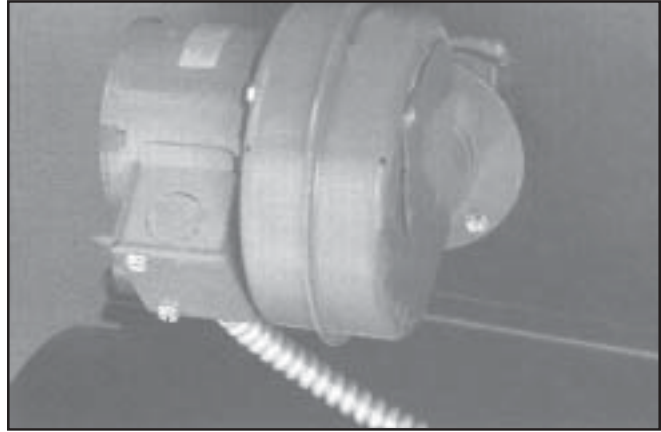

3. Attach the draft fan to the back of the weld on the throat (2" throat hole with 3 mounting holes). It's best to use the self tapping screws without the draft fan to establish threads then mount blower. The electrical box on the blower should be facing downward. Draft fan air intake cover should be set at a 20% opening, about 1/2" opening.

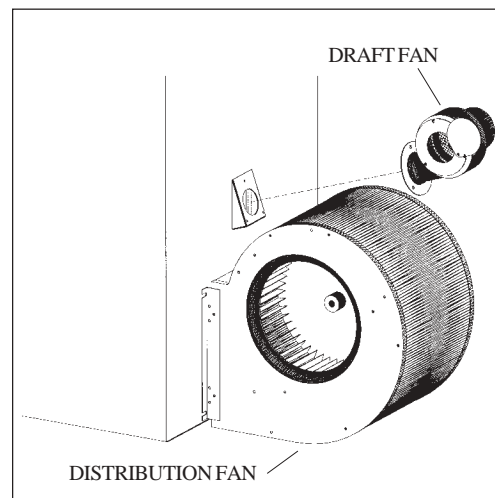

4. After mounting the two (2) fans proceed to the fan control center.

NOTE: The best maintenance for fan motors is to keep them clean (exceptionally clean). Oiling with 20W N. detergent once a season will also help, but cleanliness is what prolongs motors life. (Two (2) drops on the draft blade, four (4) drops in the distribution fan.)

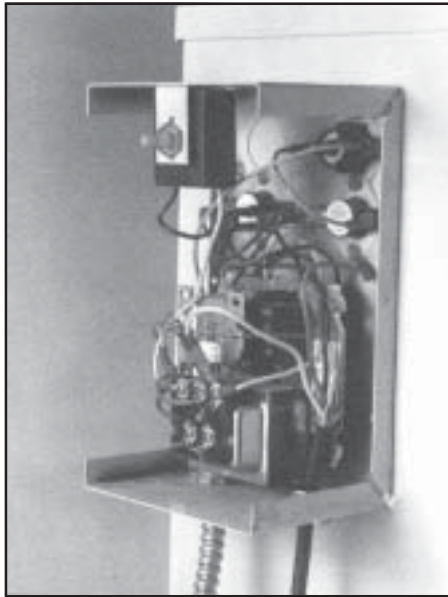

- 5a. Attaching furnace control center box. To separate outer cover, remove two (2) side screws and pull off black rheostat knob. Attach box to left side (facing feed door) with four (4) self-threading screws. One screw in each corner. (NOTE: Furnace control center is designed for left side attachment. Should space prohibit such, reversing shrouds for right side installation is possible, however, control wires from box will have to be extended.)
- 5b. Next, attach the 4x4 junction box below the control center box, using (2) self-threading screws provided in the parts bag. (Two starter holes are provided.)

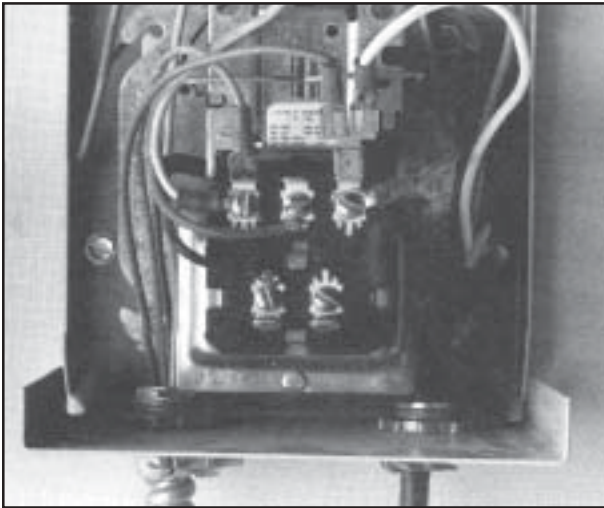

6. Attach low voltage thermostat No. 18 up to 30 ft. run No. 16 to 15ft. Run (purchase locally) to terminal plate, screws identified with letters G & R. (Generally top row center, bottom row right). Snake wire through holes in top of box. Replace outer covers & control knob. Under no circumstances should you attempt to plug in main power cord until all wiring and covers are in place. NOTE: A ground power cord plug is provided; however, local codes may require fuse box mounting.

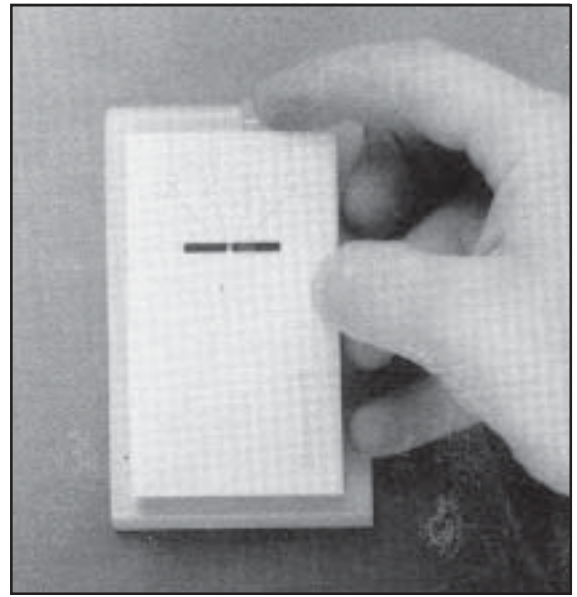

7. Wall thermostat should be mounted on an upstairs inside wall (no outside facing wall) preferably near your existing thermostat. For more specific information, read the Honeywell instruction sheet provided with thermostat. Caution: disconnect the power supply before installing. NOTE: Your wall thermostat and transfer relay are mated Honeywell products for trouble free installation.

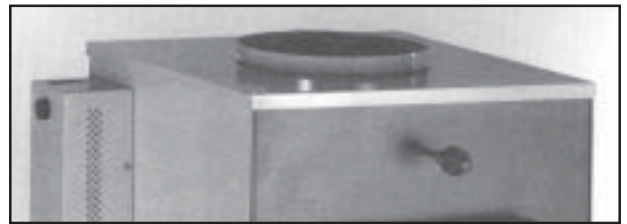

8. Install top shroud (if removed) by simply placing shroud on to the top of unit, push down, check each corner for snug fit.

CAUTION: Any hot air plenum connection to a furnace must be constructed of metal.

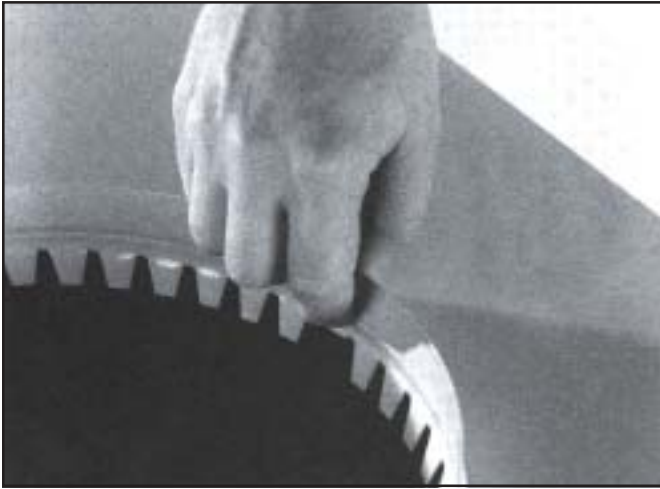

9. **Installing collar to top:** To install hot air attaching collar, simply bend all tabs right angle under shroud. This may be possible with thumbs, if not, remove top and use small hammer.

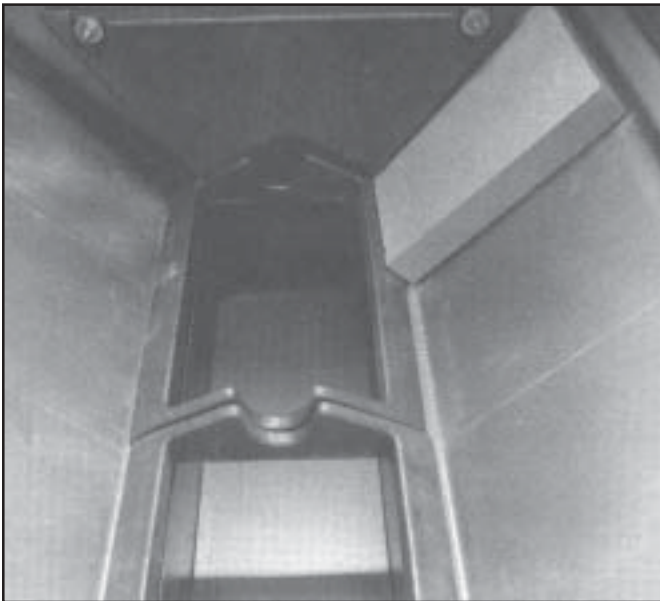

10. **Install grate frame (if not already installed):** Lay the first grate frame on the side supports and slide to the back of the unit. Then install the second grate frame to the front as shown in the picture above.

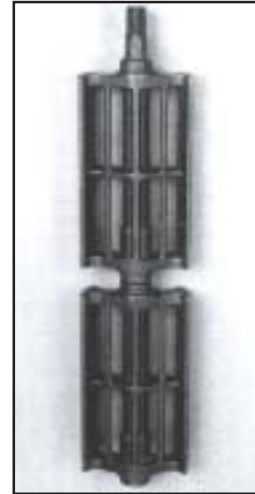

11. **Installing Grates:** Install grates together, slip shaker lug into hole and place grates into frame. Grate arch faces upward. Check out grate rotation by placing shaker handle on grate lug (3/4"). Grates should rotate freely.

NOTE: Grates are designed to withstand high temperatures, however, should you overfire the furnace you may fuse or melt grates. This happens if furnace receives too much air caused by leaving the ash and feed doors open, draft fan cover wide open, and hot coals or ashes are excessive in ash pan.



12. **Installing Firebrick:** Place 5 bricks on each side (10 brick total). The bricks tuck under firebox seem.

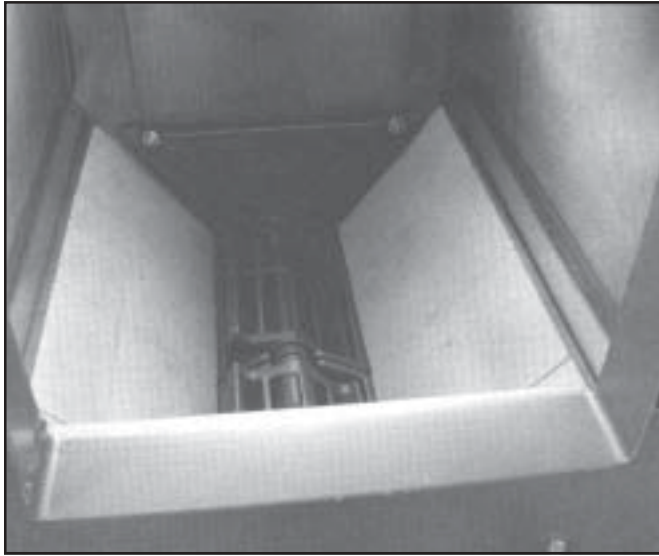

13. Installing front and rear cast baffles, heat plates.
NOTE: Grate frames and brick will slide forward and backward to allow baffle to fit. Install front cast baffle using two (2) 5/16 bolts, nuts & washers (7/16 wrench will be needed). Place the side of the baffle that has the two ribs against the front weld of the firebox. Do not tighten bolts yet. Place the rear cast baffle to the back of the firebox but do not attach the bolts at this time.

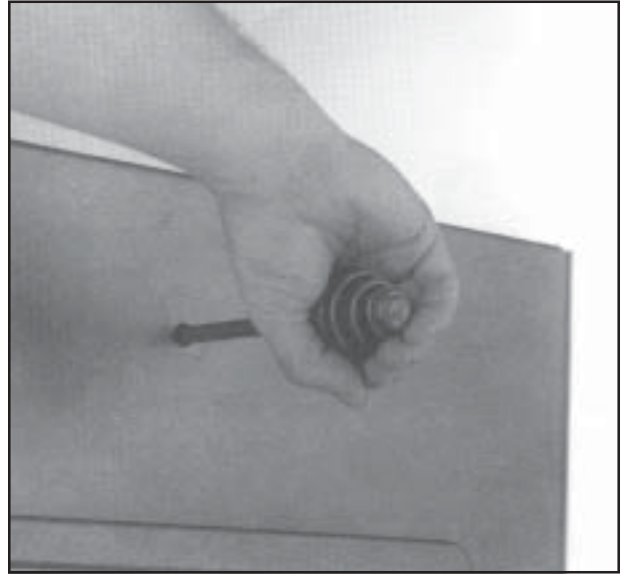

15. Installing smoke damper rod to sliding smoke damper. First, insert rod through hole above feed door and push forward.

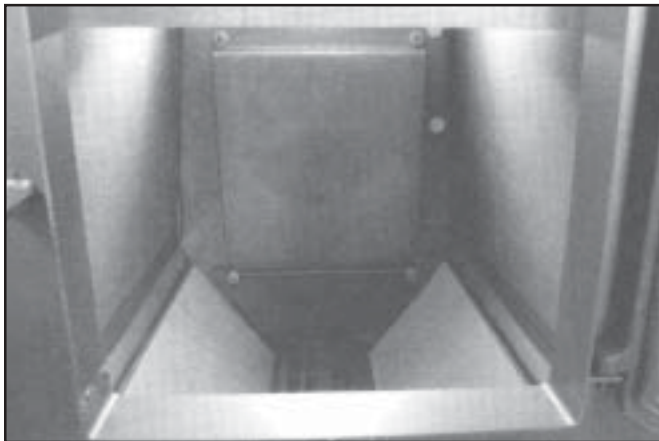

14. Now slip the rear heat plate in behind the rear baffle. Attach heat plate to the firebox by using two (2) 5/16 bolts, nuts & washers. First, line up the top holes and tighten bolts. Secondly, line up the holes in the rear baffle and the heat plate with the firebox and attach by using two (2) 5/16 bolts, nuts & washers. Tighten all four (4) bolts. NOTE: to reach rear bolts you may find it easier to put your arm through the flue outlet rather than to reach through the feed door.

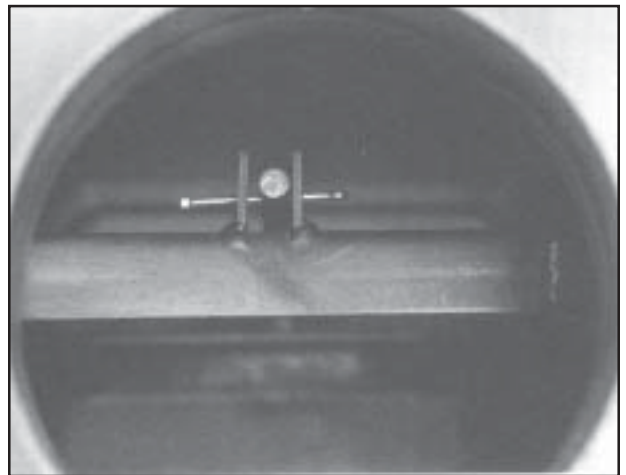

16. Next working through the flue hole behind furnace, line up rod between the two posts on the sliding smoke damper. Then line up the three (3) holes for cotter pin insertion, this procedure will test your patience. It's helpful to have a flashlight and another person positioning the rod.



17. Reposition door latches, feed and ash door.
For shipping purposes, door latches are on backwards.
Unfasten 7/16" nuts, reverse and snug fairly tight
(latches must move freely).



19. Attach flue pipe to flue collar. Flue pipe (6") fits inside
furnace flue collar. Finish off with three (3) metal
screws. NOTE: Flue pipe connections flow downward
so creosote can return to furnace for burn up.

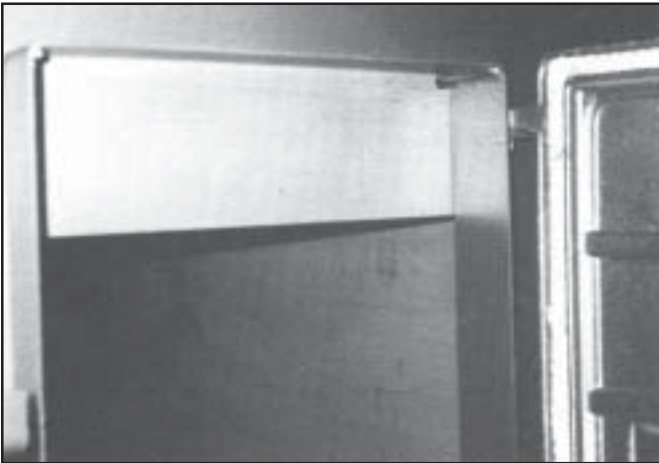

18. Installing steel smoke shield. Two (2) holes are pro-
vided above each corner of the feed door. Slide the
two (2) bolts, supplied in the parts bag, into the holes.
Next, place the two (2) clips provided onto each bolt
and then attach the two (2) nuts on each bolt. Before
tightening the bolts and nuts securely, slide the smoke
shield up under the clips, lining them with the slots in
the smoke shield. Tighten the (2) bolts and nuts. (NOTE:
The smoke shield should be able to swing back and
forth.) The smoke shield will help prevent smoke back
puffing if you have a lazy flue.

Accessories

Filter Box

Part # 24CRM

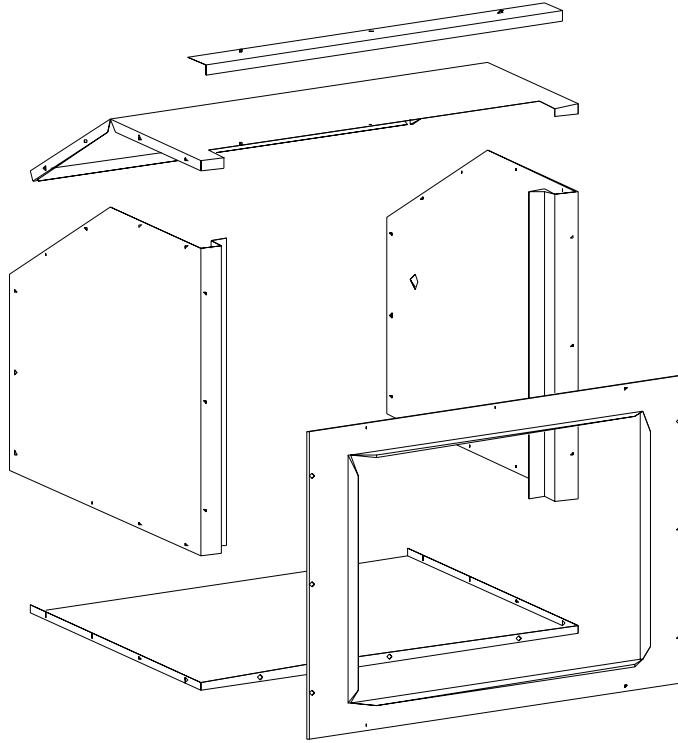

NOTE: DRAWINGS ARE FOR ILLUSTRATION PURPOSES ONLY. ACTUAL PRODUCTS MAY LOOK DIFFERENTLY.

Domestic Hot Water Coil

Part # 11WCK

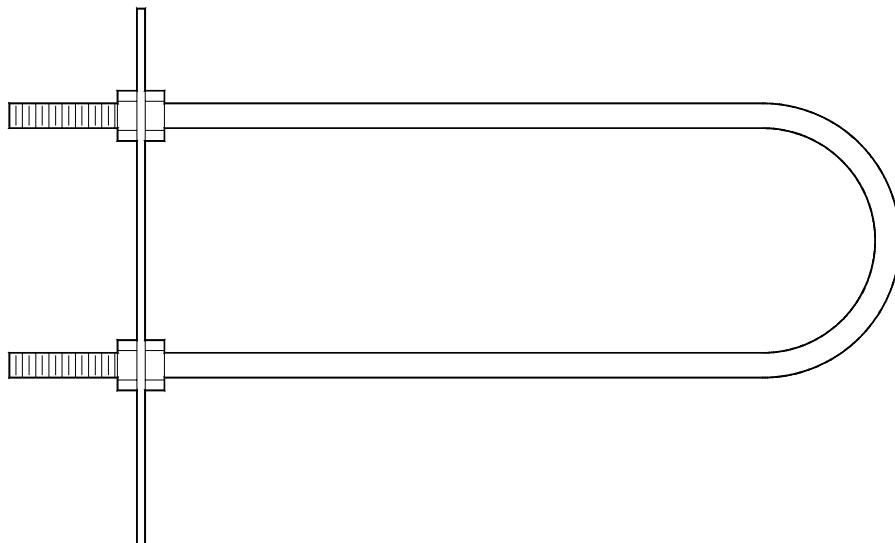

WIRING DIAGRAM

NOTE: RHEOSTAT IS ADJUSTABLE. IN CASE OF LOW VOLTAGE TURN COUNTERCLOCKWISE UNTIL BLOWER WILL RUN, BUT NOT STALL, WHEN POWER IS RETURNED TO UNIT.

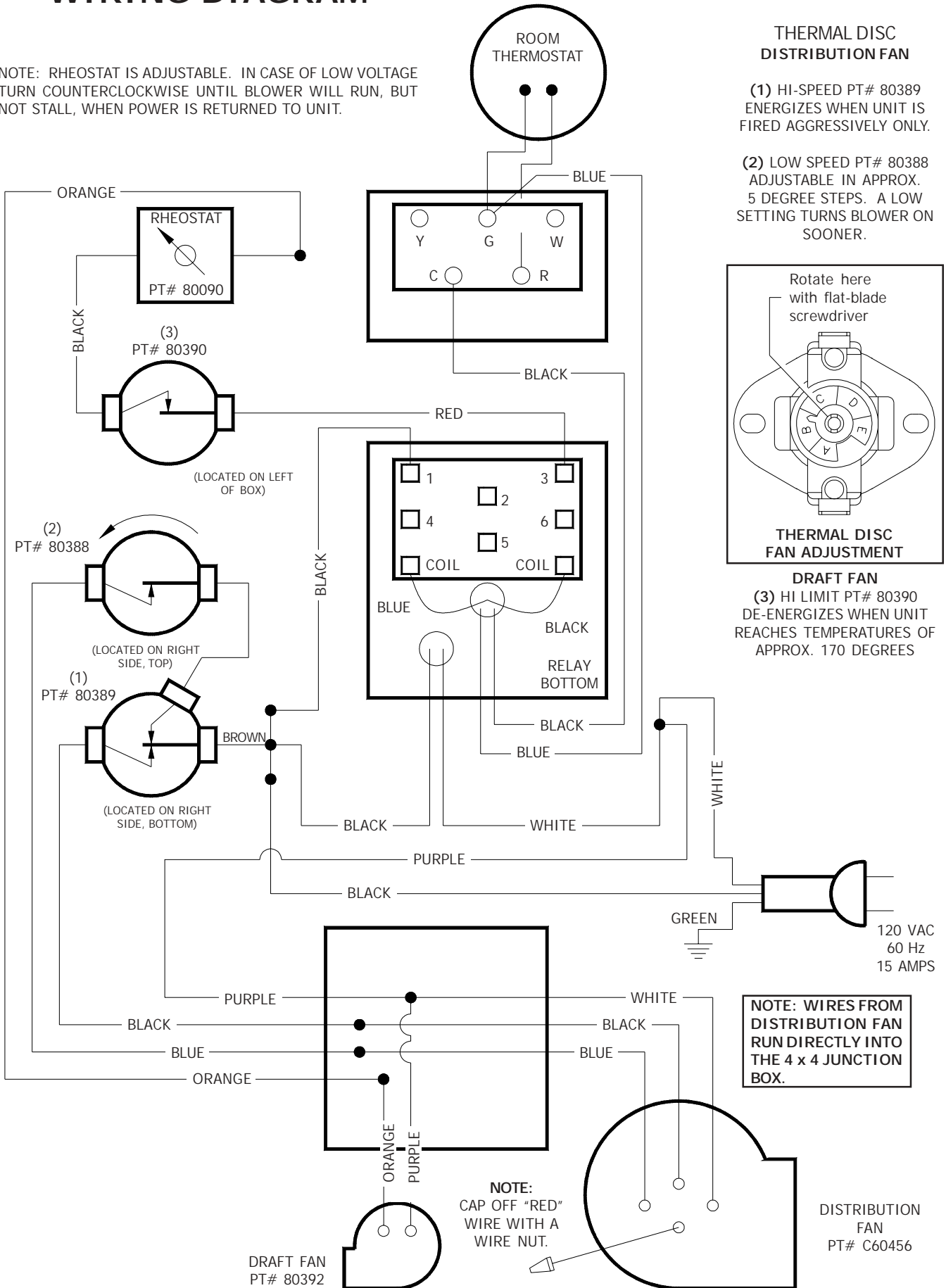

Control Box & Electrical Component

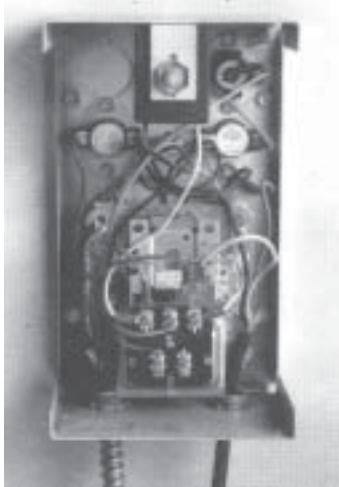

ELECTRICAL COMPONENTS

Wall Thermostat
*110 degrees Adjustable Thermo Disk
*140 degrees Thermostat
*170 degrees Thermo Limit Disk
*Relay Transformer
Air Distribution Fan
Draft, Fan

* Control Box Components

10 BASIC FUNCTIONS OF ELECTRICAL SYSTEM

1. Wall mounted thermostat requests heat...electrical contact occurs.
2. Current is sent through relay, rheostat, 170 degrees thermo limit disk to activate draft fan.
3. Relay...electrical switching device,
Rheostat...current (voltage) reducer increases or decreases draft fan R.P.M.
170 degrees limit disk...breaks off electrical current at 170 degrees (limit disk)
Draft fan...small fan that activates fire, increasing fire temperature.
4. Upon firebox temperature rise due to air from draft fan, distribution fan is activated at approximately 110 degrees air temperature, 600 CFM of air at 110 degrees.
5. 110 volts (main electrical line) is sent to left side of 140 degrees thermo disk (3 prongs) current passes through 140 degrees disk to 110 degrees disk. Current simply waiting for 110 degrees so it can pass through and activate normal speed function of distribution fan. (blue wire)
6. If 110 degrees firebox air temperature is not maintained snap disk terminates current to distribution fan. Should firebox temperature air reach 140 degrees current is directed to activate high speed portion 1300 CFM of air. Current travel from prong 1 to prong 2 on 140 degrees disk to activate high speed portion (black wire).
Distribution Capacitor: Reduces amps required to activate distribution fan.
8. Varistor: Provides even flow of current to snap disk,
9. prevents electrical surges, provides longer life of snap disk.
Transformer: Reduces voltage 110 volts to 12 volts for
10. thermostat usage. Generally hums a bit.

The above is somewhat basic, however, it's offered so you can understand your furnaces electrical functions and enjoy it more.

USSC

Your new furnace is now completely assembled and ready to be installed. Make sure you followed the sections on installation in the front of this manual.

OPERATION OF YOUR NEW WOOD BURNING FURNACE.

Check that your draft blower is in working order before lighting a fire (cover setting 20% open).

Do this by turning the room thermostat to a high temperature so that the draft blower turns on, then turn the thermostat back to proper setting thus turning the draft air blower off. Should draft blower not function, check to see if rheostat setting is on.

NOW PROCEED WITH LIGHTING A FIRE.

1. Pull bypass damper out (opens up flue hole).
2. Make sure your flue pipe damper is open. Place several pieces of crumpled paper in the center of your firebox. In a crisscross pattern, place a couple of handfuls of dry kindling wood, then several small dry pieces of firewood.

CAUTION:

Never use chemicals or fluids such as gasoline, charcoal lighter fluid, drain oil or kerosene to light a fire in your furnace. This would be like checking the level of gas in your car with a lighted match.

3. Ignite the paper and close the door. Do not attempt to open the door immediately after igniting the fire. There could be a flame flash out.
4. It will take a few minutes for the fire to establish itself. Once you have some good red hot burning coals, add larger pieces of wood. All Chimneys and hookups act differently. After a while, you will find out how your unit works best for starting.
5. Push in bypass damper after fire has progressed.
6. Your furnace is capable of putting out many BTU's, so don't fully load your furnace until you have become familiar with the operation of the furnace. Keep in mind, a full load will not always give you the best results for your needs. Note: With new steel, there is a small amount of oil or dirt on the metal. You may smell an odor. This is normal during the first operation. You may want to assemble the furnace out of doors and build a small fire in it to "burn off" this dirt and oil before installing the unit.
7. When loading your furnace that has existing hot coals, pull the bypass damper out and rake the red hot embers over grate evenly. Put a few smaller pieces of wood on the coals first, then load up to the middle of the feed door.
8. Set rheostat setting for type and condition of coal or wood. Hard coal and wood requires more forced air than soft, so experiment with dial setting. Start with a center dial setting. The draft fan cover also requires experimenting with. Start with a 20% opening.
9. Set the furnace thermostat for comfort. Set the other thermostat 10 degrees lower.
10. Use caution when opening loading door. Avoid opening loading door rapidly. This could cause flames to flash out the door. This occurs when there is unburned fuel and a large amount of gases on the top of the firebox. When the door is opened oxygen is combined with the gases and ignites.

ASH REMOVAL

Every morning when there is just a bed of hot embers, shake the grate very, very lightly.

Once every week or two, depending on how much fuel you burn, ashes should be removed. Note: A 2" to 3" bed of ashes will prolong wood burning and protect grates.

CAUTION

Never let ashes build up to grate level. This will reduce the life span of your grate, and void grate warranty.

To remove ash pan simply open ash door and pull out your ash pan. But remember, the ash pan can get very hot. Dump ashes in a metal container with a lid and place on a non-combustible surface.

CAUTION

Never use anything but a metal container to put your ashes in. Every year fires are caused by emptying ashes into cardboard boxes or paper bags.

MAINTENANCE

Keep chimney and flue pipe clean by cleaning at least twice during a heating season.

CREOSOTE-FORMATION AND NEED FOR REMOVAL

When wood is burned slowly, it produces tar and other organic vapors which combine with expelled moisture to form creosote. The creosote vapors condense in the relatively cool chimney flue of a slow burning fire. As a result, creosote residue accumulates on the flue lining. When ignited, this creosote makes an extremely hot fire.

The chimney connector and chimney should be inspected at least twice monthly during the heating season to determine if a creosote buildup has occurred.

If creosote has accumulated, it should be removed to reduce the risk of a chimney fire.

CAUTION

If you have a chimney fire, we recommend the following immediate actions:

1. Alert everyone in the house.
2. Shut any furnace doors, disconnect power to the unit, and close any dampers. This should take no longer than a few seconds.
3. Call the fire department.

Keeping your chimney and stove pipe clean is the best insurance against chimney fires. Note: Smoke detectors and fire extinguishers should always be a part of your equipment.

If you clean your own chimney and stove pipe, we recommend purchasing the equipment professionals use. Wire brushes are available in enough sizes and shapes to be a snug fit inside any common flue.

Once a week let your furnace burn with ash door open for a maximum of fifteen minutes while in attendance. This will help minimize creosote buildup. Also placing a surface magnetic thermometer on flue pipe is helpful to keep temperatures at 300 to 400 degrees. Duct temperatures should be 115 to 125 degrees at 12" above furnace.

BURNING COAL

Your furnace is capable of burning both Bituminous and Anthracite coal. Anthracite is perhaps the best coal fuel because its long even burn time, high heat output, and cleanliness make it a good choice for the home. However, keep in mind it is a much more difficult fuel to use, requires more care and patience, is not so widely available, and is usually much more expensive than bituminous.

SIZE OF COAL: Most sizes of Bituminous Coal will work in your New Furnace, for best results we recommend large nut coal to small egg coal (1-3/4" dia. to 4" dia.). When burning Anthracite, use egg or broken with sizes between 2-5/16" thru 4-3/8". Note that it is important to the long life of your furnace to buy coal which has been sized and cleaned. Cleaning insures removal of rocks and other materials. Never use coal smaller than 1" or larger than 5" in diameter. Small sized coal will smother the fire. Too large a size of coal will not burn well.

STOVE OPERATION: All coal fires should be started with wood which will allow the fire to get hot enough to ignite the coal. The best ignition fires utilize dry pine or other resinous soft woods as kindling, with hard wood (oak, hickory, ash) added to increase the heat prior to addition of the coal.

BURNING BITUMINOUS: Once your kindling and wood fire has produced a bed of well established coals, start adding coal in layers allowing each to ignite before adding more. Bituminous has a high volatile content and, as a result, should be fired with the "conical method" - with the highest portion of your firebed in the center of the firebox. The first flames will be long and generally orange or yellow and produce quite a bit of smoke. As the gases burn off the flames become shorter, change color

and produce less smoke. Once the fire is WELL ESTABLISHED add coal to the center of the firebox forming the cone. Burning in this fashion allows heat to drive off the volatile gases, and turbulence created increases the burn efficiency. You will have to experiment with your particular setup as no two chimney's or installations are going to be the same. Just remember to allow enough secondary air to enter the firebox and keep your stove pipe damper open so that volatiles are properly burned. Before refueling, take the time to break up the cone a little with a poker, especially if it has caked over or formed a crust. But, be careful not to mix the coal as this increases the chances of forming clinkers. When shaking the grate(s) be gentle. Just a few short movements is better than a lot of agitation. The objective is to remove a small amount of the ashes without disturbing the fire. Stop when you see a glow in the ashes or the first red coals fall into the ash pan. Excessive shaking wastes fuel and can expose the grate(s) to very high temperatures which can cause warpage or burnout.

For overnight operation (long duration burn time) shake the fire and add coal, retaining your center cone. Once the volatiles are burned off, close the feed door and adjust your stove pipe damper. Then adjust your thermostat to the desired heat level.

You will have more MAINTENANCE with bituminous than with anthracite coal as more soot will collect on heating surfaces and in pipes, requiring more frequent cleaning.

ANTHRACITE: Before starting the fire open - the stove pipe damper, open the ash pit door and feed door, place newspaper, finely split kindling on the grate, and light the paper. Add larger hard wood after kindling is burning brightly. **CAUTION: Never use gasoline, lantern fuel, kerosene, charcoal lighter fluid, or other flammable liquids to start or freshen up a fire in this heater.** Place the larger pieces of wood on the fire so that they are slightly separated and form a level for the addition of coal. It will take 10 to 20 minutes before this wood is thoroughly ignited. Adding coal too soon will cut the air supply and smother the fire.

Add a thin layer of coal (preferably smaller chunks) to the wood fire, being careful not to disturb it too much or cut off the draft. Then, add a second heavier layer after the coal is ignited and burning well. If necessary, add a third layer to bring the coal up to the top of the front liner (not above!). Be sure you have closed your ash door.

Before adding further fuel, be sure you leave a red spot of glowing coals in the center of the firebox to insure that you have not smothered the fire and to help ignite the

gases given off by the new charge. A deep charge will give a more even heat and a longer fire, but it may take one to two hours before the whole bed is fully ignited.

When the fire is well established and the room is becoming warm, partially close the dampers. You will have to experiment with your particular setting of the damper and controls as your chimney provides the draft necessary to not only exhaust the smoke, but to pull combustion air into the heater as well - and no two chimneys perform the same. Leave the ash pit damper at least partially open to prevent the fire from going out. Adjust the stove pipe damper to reduce the draft on the fire. With anthracite you will see short blue flames above the coal, except when the fire is started or a new charge is added. If, however, there is no flame then the fire needs more air from the bottom (unless it is near the end of its burn cycle and needs to be recharged).

Only when the coal is burned down to half its original depth is it time to add fresh coal. When doing so, open your stove pipe damper, which will allow the fire to burn off any accumulated gases. Open the feed door, and with a small rake, hoe or hooked poker pull the glowing coals to the front of the firebox. Try not to disturb the fire too much. Next, add a fresh charge to the back being careful not to seal off the top. Close the feed door but leave the spin damper open for a few minutes until the volatile gases have burned off. It is not necessary to shake down the ashes each time you refuel your furnace. Experience will be your best teacher.

BANKING THE FIRE: For extended operation, such as overnight, you will need to bank the fire. To do so heap coal up along the sides and back of the firebox so that the fire gradually burns it over a longer period of time. You will also reduce the intensity of the fire without letting it go out. Follow the same procedure as for refueling. If possible, avoid shaking, as a heavier layer of ash will help reduce the intensity of the fire during this time. After loading, let the fire establish itself for about 30 minutes. Then close your damper to the point where the house does not become too cold. It is important that you begin banking early enough before retiring or leaving that you can make necessary adjustments after the fire is well established.

To revive a coal fire that is almost out, you should (1) open the ash door and stove pipe damper to get a good draft through the grate. (2) place a thin layer of dry coal over the entire top of the fire. **DO NOT POKE OR SHAKE THE FIRE AT THIS TIME!** (3) after the fresh coal has become well ignited shake the grate (just a little) and you will be ready to refuel.

DO NOT burn coke, charcoal, high volatile bituminous coal, sub bituminous, lignite or cannel coal (sometimes called channel coal or candle coal). NEVER burn wax or chemically impregnated sawdust logs - their intended use is for fireplaces only. NEVER fill your stove or furnace above the firebrick or cast iron liner.

SHAKING

Shaking should be done only when there is a hot fire.

The frequency of shaking will depend on the degree of burning. Shaking should be done at least once a day and preferably twice a day.

Best results from shaking the rocker grates will occur if short "choppy" strokes are used rather than long, even strokes.

The amount of shaking is critical. Too little or too much of both can result in the extinguishing of a fire due to blocked air flow. The proper amount normally occurs when red coals first start to drop through onto the bed of ashes.

No furnace ever should be "poled" from the top. This can lead to clinker formation and compacting of the coal and ashes, which results in clogged air passages.

ASHES

Ashes never should be allowed to accumulate in the ash pit so that they in any way impede the flow of combustion air to the fire. Excess ash accumulation can cause the fire to go out and also can cause severe damage to the grates because of the absence of a cooling flow of air beneath them.

Ashes always should be emptied into a metal container. Coals can remain hot many hours after a fire is out. Coal ashes should not be put on gardens as they do not contain beneficial minerals like wood ashes, and may cause ground water pollution.

Coal produces considerably more ash than wood, so the intervals between emptying are much shorter. For equal heat output, coal will produce seven (7) to ten (10) times more ash than wood.

CLINKERS

Clinkers can occur in any coal furnace during the process of burning. These are hard pieces of fused ash that form in the firebox. They can become hard and large in size and, therefore, cannot be shaken through the grates in a coal stove. When there is an appreciable accumulation, the fire will go out because insufficient air is allowed to pass through the clinkers to the burning coal.

Once large clinkers have formed, they can be removed only from above the grates. This usually means the fire must be allowed to go out before they can be removed.

Clinkers formation can occur from a number of different causes or a combination of causes. Some of these are:

- Poor quality coal-excess ash content and/or too low a heat of fusion.
- Too hot a fire (too much draft).
- Too shallow a bed of coals.
- Too deep a bed of coals.
- Excessive Shaking.

- Poking the fire from the top.

- Too little air (draft) after a long, hot fire (caused by rapid adjustment of draft from a very high setting to a low setting).

If clinkers do form, the coal quality should be checked first, and then all the above points should be reviewed and corrected.

SAFETY

Whenever a loading door is opened, the bypass damper should be opened first (use a glove to protect you hand), and the door should be cracked slightly (for about ten (10) seconds) to allow oxygen to enter and burn any combustible gases that are present before fully opening. Failure to do this could result in sudden ignition of the unburned gases when the door is opened.

With the exception of the start-up period, the ash pit door should never be left open. Serious damage to the stove can occur from overheating. In extreme cases, this overheating could be the cause of an "unfriendly fire".

Coal furnaces are subject to the same installation clearance standards as wood furnaces. Never burn coal in any furnace that does not have an airtight, unified chimney system.

Coal furnaces should not be installed in any chimney that has had a history of back-drafting or flow reversal. Also, coal furnaces should not be installed in any chimney having an excessively large flue. These conditions can cause improper draft, resulting in carbon monoxide entering the house rather than being drawn up the chimney. Remember, coal gases are toxic.

Sulfur dioxide, sulfur trioxide and other ions released from coal burning may corrode stainless and masonry chimneys, and even terra cotta chimney liners and brick in nearby buildings. Coal with high sulfur content will destroy chimneys especially fast if soot sits in the flue for extended lengths of time. It is important to clean chimneys regularly.

Trouble-Shooting

TROUBLE-SHOOTING, PROBLEM SOLVING FOR YOUR FURNACE

1. **Problem:** Smoke puffs from furnace.
Solution:
 - A. Check chimney draft. Check for blocked chimney or flue pipe. Use mirror to check chimney clearance.
 - B. Check ash pit - if too full, empty.
 - C. Make sure furnace room is not too airtight.
 - D. Make sure all chimney mortar connections are air tight.
 - E. Check clean out door. Make sure it's airtight.
 - F. Check chimney for possible down-draft caused by taller surrounding trees or objects. Correct with proper chimney vent cap.
 - G. Check the possibility of cold chimney forcing cool gas blockage. Remedy by properly insulating chimney with noncombustible liner and non-combustible insulation.
 - H. Fuel may be too wet.
 - I. Make sure no other fuel burning devices are connected to the chimney impairing the draft.
 2. **Problem:** Inadequate heating being delivered to your home.
Solution:
 - A. Check home insulation - is it adequate?
 - B. Check hookup to furnace - is it installed correctly? (review manual)
 - C. Cool air inlet may be inadequate or furnace room too airtight, 14" inlet for 12" outlet.
 - D. Your wood fuel may be too low grade. Hard woods are recommended.
 - E. Make sure your hot air duct (and other duct work) is airtight.
 - F. If furnace room is warm but your home isn't, check back draft dampers.
 - G. Is air inlet to the blower open? Check filters.
 - H. Fuel may be too wet.
 - I. Check draft blower cover, setting 1/2" opening.
 - J. Rheostat setting is fully open.
 3. **Problem:** Excess smoke or flames coming out door when refueling.
Solution:
 - A. Open bypass damper. Wait 15 seconds and open door slowly - then refuel.
 - B. Check length of flue pipe to chimney. Your unit should be within six (6) feet of your chimney.
 - C. Make sure chimney cap is not too close to the top of the chimney.
 - D. Check chimney draft-make sure chimney flue pipe is clean and chimney is of adequate height.
 - E. Make sure you're not suffocating the fire with excess amounts of unburned fuel.
 4. **Problem:** Distribution blower vibrating.
Solution:
 - A. Tighten Allen Screw on squirrel cage.
 - B. Check for bad fan bearings.
 - C. Also oil 3-4 drops of 20w non detergent oil.
 5. **Problem:** Distribution blower continues to run or will not run.
Solution:
 - A. Check to see if thermodisc 110 degrees (top right side) is faulty. Use match or lighter for click or jumper wire.
 - B. Check to see that blower is properly wired. (See Wiring and Assembly Instructions).
 6. **Problem:** Draft blower continues to run or will not run.
Solution:
 - A. Check rheostat switch for on position. Check wiring.
 - B. Check thermostat or thermostat wire for short.
 - C. Make sure temperature is calling for or not calling for heat. Set thermostat at 80 degrees.
 - D. Check to see if thermodisc 170 degrees (left side) is faulty. Use match or lighter for click or jumper wire.
- Problem:** Odor from first fire.
7. **Solution:**
 - A. The odor remains, call your dealer immediately. A defective weld can cause a fume leak.
- Problem:** Excessive creosote.
8. **Solution:**
 - A. Check the grade of wood you are burning.
 - B. Make sure your unit is serviced by its own proper chimney.
 - C. check length of flue pipe and its connections.
 - D. Make sure you are burning the smallest, hot test fire to adequately heat your home.
 - E. Also see Solutions to Problem 1.
 - F. Use a magnetic surface thermometer on flue pipe and operate between 300 and 400 degrees.
- Problem:** Poor seal around unit door.
9. **Solution:**
 - A. Bend door latch in to tighten seals.

Notes

HOW TO ORDER REPAIR PARTS

THIS MANUAL WILL HELP YOU OBTAIN EFFICIENT, DEPENDABLE SERVICE FROM YOUR FURNACE, AND ENABLE YOU TO ORDER REPAIR PARTS CORRECTLY.

KEEP THIS MANUAL IN A SAFE PLACE FOR FUTURE REFERENCE.

WHEN WRITING, ALWAYS GIVE THE FULL MODEL NUMBER WHICH IS ON THE NAMEPLATE ATTACHED TO THE HEATER.

WHEN ORDERING REPAIR PARTS, ALWAYS GIVE THE FOLLOWING INFORMATION AS SHOWN IN THIS LIST:

- 1. THE PART NUMBER**
- 2. THE PART DESCRIPTION**
- 3. THE MODEL NUMBER: 24AF 24AG 24AZ**
- 4. THE SERIAL NUMBER: _____**



**UNITED STATES STOVE COMPANY
227 INDUSTRIAL PARK ROAD
PO BOX 151
SOUTH PITTSBURG, TN 37380
(423) 837-2100
www.USSTOVE.com**

