

MAGNUM 6500[®] / 7500[®]

CORN/WOOD PELLET FURNACE

THIS APPLIANCE HAS BEEN TESTED AND APPROVED TO CSA B 366.1-M91-CAN/USA & UL 391-99

OWNER'S MANUAL

Installation – Operation – Maintenance Instructions

WARNING: THIS INSTRUCTION MANUAL MUST BE SAVED FOR FUTURE REFERENCE

PLEASE READ THIS ENTIRE MANUAL BEFORE INSTALLATION AND USE OF THIS CORN/WOOD PELLET BURNING FURNACE. FAILURE TO FOLLOW THESE INSTRUCTIONS MAY RESULT IN PROPERTY DAMAGE, BODILY INJURY OR EVEN DEATH.

REFER TO ADDITIONAL MARKINGS ON APPLIANCE FOR ADDITIONAL INSTRUCTIONS

IMPORTANT: Always contact your local dealer/installer with questions before contacting the factory. When you call have your serial number, purchase date, who installed the unit and a list of questions.

This appliance must be installed by a licensed/trained factory approved installer

- ✓ When installing your **Magnum 6500/7500 Corn/Wood Pellet Furnace**, particular attention needs to be made in regards to fire protection. If the unit is not properly installed, a house fire may result. For your safety, follow the installation and operation instructions provided, and if a question arises contact local building or fire officials about restrictions and installation requirements in your area.
- ✓ Read the operations and fuel section of this manual before plugging in your unit.
- ✓ Always unplug the unit before attempting any service work.
- ✓ Do not connect the unit to a chimney flue already serving another appliance.
- ✓ When installing the chimney pipe to the unit, it is important to remember that the unit operates on a negative pressure and the chimney on a positive pressure. All chimney connections, elbows and fittings must be airtight. **(proper venting practices must be followed. Consult with a venting professional)**
- ✓ Ashes must be disposed of in a metal container with a tight fitting lid. Do not let ashes build up in ashpan.
- ✓ All minimum clearances to combustibles must be followed. Ductwork clearances must be maintained.
- ✓ The **Magnum 6500/7500 Corn/Wood Pellet Furnace** is tested for operation with 14% or less moisture corn or with wood pellets with an ash content of no more than 3%. **It is recommended that Corn with 11-12% moisture or wood pellets with an ash content of 1% or less be used for efficient operation of this unit. Corn over 12% moisture has a lower BTU value and will be hard to burn on the lower settings. Fuel over 12% moisture will dramatically reduce the heating ability of this appliance.**
- ✓ **It is important to use fuel that is clean, dry and consistent.** Make sure that your supplier is giving you the same fuel each time that you purchase. It is recommended that you purchase your entire heating season supply of fuel at one time so that the fuel will be the same.
- ✓ **A voltage surge protector or ground fault outlet is required for this unit. The warranty on the circuit board will be voided if proper surge protection is not installed before operating this unit**
- ✓ **Proper voltage, polarity and grounding must be assured for appliance to operate correctly. Consult with your electrician before operating this appliance to assure electrical is proper.**

AMERICAN ENERGY SYSTEMS, INC. GRANTS NO WARRANTY, IMPLIED OR STATED, FOR THE INSTALLATION OR MAINTENANCE OF THE STOVE AND ASSUMES NO RESPONSIBILITY FOR ANY CONSEQUENTIAL DAMAGE(S).

Disclaimer Notice: No guarantee is made regarding the heating capacity of this unit. The actual area that this unit will heat depends on factors such as fuel quality, fuel moisture, installation configuration, venting and fresh air configuration, operational practices, conditions of the building, heat loss, type of construction, amount and type of insulation, type of air movement, and the location of the Furnace.

AMERICAN ENERGY SYSTEMS, INC. -150 Michigan Street SE - HUTCHINSON, MINNESOTA 55350

Web Site: www.magnumheat.com

Rev. date 01/01/08

TABLE OF CONTENTS

PAGE

| | |
|---|-------|
| INTRODUCTION & SPECIFICATIONS..... | 3 |
| UNPACKING YOUR MAGNUM 7500 CORN/PELLET FURNACE / SAFETY STEPS.... | 4-6 |
| BURNING SOLID FUELS (SHELLED CORN AND WOOD PELLETS)..... | 7-8 |
| CLEARANCE TO COMBUSTIBLES..... | 9 |
| FLOOR PROTECTION..... | 10 |
| GUIDELINES FOR EXHAUST VENTING SYSTEMS DESIGNS..... | 11-13 |
| DESIGN GUIDELINES FOR OUTSIDE COMBUSTION AIR CONNECTION..... | 14 |
| INSTALLATION CONFIGURATIONS..... | 15-17 |
| DUCTING..... | 18-20 |
| GLASS MAINTENANCE, ADJUSTMENT, REMOVAL AND REPLACEMENT..... | 21 |
| STOVE CONTROLS..... | 22 |
| COMBUSTION ENHANCEMENT SYSTEM (CES)..... | 23 |
| LIGHTING INSTRUCTIONS..... | 24 |
| CIRCUIT BOARD FUNCTIONS..... | 25 |
| SETTING THE DRAFT..... | 26 |
| 6500 LIGHTING INSTRUCTIONS /CIRCUIT BOARD FUNCTIONS/SETTING DRAFT | 27-29 |
| MAINTENANCE INSTRUCTIONS..... | 30-32 |
| AUTOMATIC SAFETY FEATURES..... | 33 |
| THERMOSTAT INSTALLATION..... | 34 |
| MAGNUM 7500 WIRING DIAGRAM..... | 35 |
| MAGNUM 6500 WIRING DIAGRAM..... | 36 |
| TROUBLE SHOOTING GUIDE..... | 37 |
| SETTING THE CIRCUIT BOARD..... | 41 |
| DRAFT SLIDE GATE CORRECTOR INSTALL AND ADJUSTMENT..... | 42 |
| REPLACEMENT PARTS LIST..... | 43 |
| WARRANTY INFORMATION..... | 44 |
| SERVICE RECORD..... | 45 |
| WARRANTY REGISTRATION CARD.....(IN HARDWARE PACKET) | |

DEAR VALUED MAGNUM 7500 OWNER,

We appreciate your decision to help preserve our precious environment by purchasing the **Magnum 6500 or the 7500 Corn/Wood Pellet Furnace**. With everyone working together, we can have clean air and renewable heat for our homes. Making a decision today to conserve energy will result in lower energy costs tomorrow along with conserving our precious natural resources.

Please read this Owners Manual carefully before using this appliance and if you have any questions contact your local **Magnum** reseller. We appreciate your business and wish you many warm days and nights with your new **Magnum 6500/7500 Corn/Wood Pellet Furnace**.

Sincerely,

Mike

Mike Haefner, President
American Energy Systems, Inc.

P.S. You are very important to the success of our business and your referral of our products is very much appreciated. Many of our Resellers have referral rewards available and I encourage you to ask your local dealer how to get involved in helping make our country energy self-sufficient. **GOOD LUCK !**

SPECIFICATIONS

American Energy Systems, Inc., manufacturer of the **Magnum 6500/7500 Corn/Wood Pellet Appliances**, reserves the right to alter its products, their specifications and/or price without notice.

Safety tested by Warnock Hersey to UL 391-99, CAN/CSA-B366.1-M91,

| | |
|--------------------------|--|
| Heat Input* | 7500 = up to 78,000 BTU/hr with corn 6500 = up to 78,000 BTU/hr with corn |
| Fuel Storage Capacity | 180-210 Lbs. |
| Width | 26" |
| Height with Pedestal | 47 ½" |
| Depth (includes ash lip) | 36" |
| Shipping Weight | 480 pounds |
| Electrical Requirements | 115 volts – 60 cycle – 10 amp Circuit |
| Flue Size (rear exit) | 3" or 4" Type L Vent |
| Warm Air Outlet | 12" Round or 14" x 14" rectangular |
| Room Air Blower | 1240 CFM furnace blower |
| Cold Air Return | 14" x 24" |
| Filter Size | 16 x 25" |
| Overall unit efficiency | As high as 87% |
| Total Amp. Draw | Full load = 9 amp. |

*BTU input can vary from 10-60 percent, depending on the brand of fuel, size of fuel, quality of fuel and moisture content. Improper installation, venting configuration, combustion air configuration and maintenance practices will seriously decrease the heating ability of this appliance. Consult your authorized Magnum reseller for information to get the best results out of your Magnum appliance.

UNPACKING YOUR MAGNUM CORN/PELLET/ BIOMASS FUEL FURNACE

When you receive your **Magnum Corn/Pellet Furnace**, be careful to inspect all parts and components to make sure that nothing was damaged or lost in shipment. If there was shipping damage, be sure to report it to your Magnum reseller, and the shipping company that delivered your unit. **Freight damage claims must be made to the Freight Company (not the AES factory) immediately.** If parts are missing contact your local **Magnum** reseller or contact the factory right away. **Your satisfaction is our top priority.** If damage is not reported to the freight company before signing for it, you will not receive reimbursement for freight damage.

To uncrate your **Magnum Corn/Pellet Furnace**:

- 1) Cut the banding straps and open the carton lid. The carton is stapled to the wood pallet so it will be necessary to pull the cardboard loose from the pallet. Remove the crating box carefully lifting up over the top of the unit. Be careful not to scratch the unit with the staples. Remove the wood blocks and plastic. We strongly urge you to recycle the packaging materials to help protect the environment.

SAFETY STEPS

IMPORTANT: Proper installation of this furnace is crucial for proper and safe operation. Installing this product improperly may result in a house fire and personal injury. All applicable building codes for your location must be followed. In areas where building codes require additional steps to the installation of this product not included in this manual, the building codes will take precedent and must be followed. Contact your local building inspector to obtain any necessary permits or inspection guidelines before installing the product. **(This appliance must be installed and serviced by a trained licensed heating contractor to assure proper installation and warranty of this product) The label located on the back of the appliance must be filled out by a Licensed HVAC contractor. Warranty Labor, parts, shipping or any other costs will not be covered if a trained installer does not install the unit.**

Consult your local heating contractor for proper heating requirements, placement of your Magnum Corn/Wood Pellet Furnace and duct sizing.

OUTSIDE AIR HOOKUP TO THE FURNACE IS REQUIRED (3" diameter minimum, 4" recommended)

This furnace has to be exhausted with 3" or 4" class L vent. Furnace cannot be vented with another appliance. 4" venting is recommended on the model 7500 and required on the model 6500 furnace.

- ✓ **DISCONNECT THE POWER CORD BEFORE SERVICING THIS FURNACE.** A **power surge protector is required.** The unit must be plugged in to a **grounded** 110 -volt power source.
- ✓ Always route the power cord away from the unit. Do not route cord in foot traffic areas. Do not pinch cord under furniture. Do not add any additional length to the power cord.
- ✓ This product requires simple periodic maintenance for proper operation and long life of the furnace. Read and follow the maintenance schedule closely.
- ✓ **The Magnum Biomass furnace is designed, approved and tested to burn shelled corn, switch grass, oats, barley, wheat, edible beans or wood pellets.** The burning of other solid fuels such as cord wood in this furnace is not permitted. If you are burning fuels not approved for this appliance it will void the warranty and no service/warranty will be allowed. **When burning fuels other than corn, consult your dealer for proper heat setting adjustments. You will have to run your unit on lower settings when burning smaller size fuel.**

The Magnum 6500/7500 will burn high ash content fuels but will require additional maintenance/cleaning.

- ✓ A working smoke detector must be installed in the same room as this product.
- ✓ Flammable or explosive liquids such as gasoline, naphtha or engine oil must NEVER be used in or around this stove. These liquids must be stored well away from this furnace as the open flame in the burner chamber could ignite the fumes of such liquids. **Do not burn garbage in this unit.**
- ✓ According to HUD requirements, when installed in a mobile home, this stove must be grounded directly to the steel chassis of the mobile home and bolted to the floor.
- ✓ The moving parts of this stove are propelled by high torque electric motors. The auger and Fuel Stirrer can cause severe injury to body parts that may get near them. Keep all body parts away from the auger and Fuel Stirrer while the furnace is plugged into an electrical outlet. These moving parts may begin moving at any time while the furnace is plugged in.
- ✓ This unit may be installed on a non-combustible surface. Make sure that the unit is level. This unit must have floor protection of at least 6 inches (150mm) in front and 6 inches (150 mm) on either side of the fuel loading and ash-removal doors.
- ✓ Do not attempt internal service to the unit when it is burning and or plugged into power.
- ✓ It is important to plan your installation so that service work can be performed on the appliance. Leave ample space around the furnace to open cabinet doors. Minimum clearances to combustibles must be maintained.
- ✓ Your Magnum reseller is required to go over in detail with the owner/operator as to the correct operation of the furnace and its components.
- ✓ Never block or obstruct any air intake ports including the vents on the furnace panels. Overheating can occur without proper air movement.
- ✓ Make sure your circuit is not overloaded as to cause the furnace to lose power.
- ✓ Furnace must be installed with adequate return and supply duct systems. Failure to have adequate return air to the furnace will void your warranty.
- ✓ **A minimum rise of 5' is required on all side vent applications.**
- ✓ Proper cleaning and maintenance is necessary. You will need to follow the directions for cleaning that are in this manual. A furnace that is properly maintained and cleaned will give you years of trouble free performance.
- ✓ The warm-air supply-duct system must be constructed out of materials that will withstand a minimum temperature rating of 250 degrees Fahrenheit. Plenums installed to the furnace must be constructed out of metal. **It is the responsibility of the homeowner to assure proper ducting installation.**
- ✓ The warm-air supply outlet of the supplementary furnace cannot be connected to the cold-air return inlet of the central furnace (series) because a possibility exists of components of the central furnace overheating and causing the central furnace to operate other than intended.

- ✓ **DO NOT USE DUCT ELBOWS HAVING AN INSIDE RADIUS OF LESS THAN 6 INCHES (150MM) ON THE (oil, electric, gas) furnaces.**
- ✓ **DO NOT CONNECT DUCTWORK SO THAT A REVERSE FLOW IS POSSIBLE. IT IS REQUIRED TO HAVE PROPER BACK DRAFT DAMPERS BETWEEN THE 6500/7500 FURNACE AND THE DUCTWORK THAT YOU ARE INSTALLING INTO AND ALSO IN THE PLENUM OF THE PRIMARY FURNACE.**
- ✓ **OPERATE THE (gas, oil, electric) FURNACE PERIODICALLY TO ENSURE THAT IT WILL OPERATE SATISFACTORILY WHEN NEEDED.**
- ✓ **THIS APPLIANCE IS CERTIFIED FOR INSTALLATION ONLY AS SHOWN IN THIS INSTALLATION MANUAL. SEE DIAGRAMS ON PAGES 15-17**
- ✓ **DO NOT RELOCATE OR BYPASS ANY OF THE SAFETY CONTROLS IN THE ORIGINAL (gas, oil, electric) FURNACE INSTALLATION.**
- ✓ **DO NOT CONNECT TO ANY GAS FURNACE THAT HAS NOT BEEN CERTIFIED INITIALLY AS COMPLYING WITH CAN/CGA-2.3**
- ✓ **A GAS FITTER WHO IS RECOGNIZED BY THE REGULATORY AUTHORITY MUST VERIFY THE OPERATION OF THE GAS FURNACE FOR ACCEPTABLE OPERATION BEFORE AND AFTER INSTALLATION OF THE ADD-ON APPLIANCE.**
- ✓ **DO NOT CONNECT TO ANY GAS FURNACE THAT IS NOT EQUIPPED WITH AN AIR-CIRCULATION BLOWER, OR TO A CHIMNEY OR VENT SERVING A GAS FURNACE OR GAS APPLIANCE.**
- ✓ **THE MAGNUM 6500/7500 CORN/WOOD PELLET FURNACE IS COMPATIBLE WITH THE FOLLOWING (gas, oil, electric) INPUT SIZES: 50,000 to 200,000 BTU.**
- ✓ The Magnum 6500/7500 Corn/Wood Pellet furnace should only be installed on a furnace duct system and venting that is in good operating condition. It is recommended and sometimes necessary to install separate ductwork because the existing ductwork might not support the proper air flow or temperature.
- ✓ The installation of the Magnum 6500/7500 Corn/Wood Pellet furnace must comply with requirements of CAN/CSA-B365, and changes to the installation should comply with CSA B139 (for oil-fired), C22.1 (for electric), or CAN/CGA-B149.1 or CAN/CGA-B149.2 (for gas-fired)

Prior to installation you will need to determine the compatibility of the existing furnace to the Magnum 6500/7500 Corn Furnace. Following are the guidelines for determining compatibility.

CFM compatibility would be rated at app. 1250 CFM. If the cfm in the central furnace is less than this a back draft damper will need to be installed in the plenum of the central furnace. The static pressure in the ductwork cannot exceed the name plate rating on the central furnace and must be compatible with the static pressure rating on the name plate of the Magnum Corn Furnace.

Adjust the static pressure in the ductwork to maintain a temperature rating of 130-150 deg. F.

Note: If the installation requirements are not followed your Magnum furnace will not operate or heat properly. This is not the fault of the appliance and the warranty may be voided if any damage to the heat exchangers is a result of improper installation.

BURNING SOLID FUELS (Shelled Corn and Wood Pellets)

Unlike petroleum and natural gas products, solid fuels such as corn and wood pellets create ash as the fuel is burned. Even with the highly efficient flame your **Magnum** will produce, the solid fuels used will produce ash. This ash will have to be cleaned out of the furnace from time to time. The cleaning procedure will be discussed later in this manual. You can minimize the amount of cleaning required and maximize the efficiency of your furnace by maintaining the correct draft settings.

The draft setting on your furnace may have to be changed from time to time to accommodate your specific burning conditions. Proper draft setting will be discussed later in this manual. The point we wish to make here is that your **Magnum furnace**, due to the nature of solid fuels, will require brief periodic attention. Please do not expect to light your furnace and walk away from it until you want to shut it off in the spring. A few moments of adjustment and cleaning from time to time are an important part of burning solid fuels.

The **Magnum 6500/7500 furnace** has been designed to burn shelled corn and other agricultural rated fuels or wood pellets that meet the Association of Pellet Fuel Industries standards. Since both of these fuels vary greatly in quality and consistency, AES cannot be responsible for damage done to your furnace due to fuel problems. The following are guidelines to using and selecting proper fuels for your furnace.

SHELLED CORN (11-12 percent moisture recommended)

- ✓ Store your corn supply in a dry place and keep the bags or container sealed to prevent your corn from absorbing excess moisture. Test the moisture content periodically to maintain the proper dryness.
- ✓ **Check your Corn for foreign objects. Your furnace warranty will not cover damage done to your furnace and/or auger system due to foreign objects in the fuel supply.**
- ✓ **Do not carry your corn supply over into the next heating season if possible unless properly stored.** If you carry over your corn supply make sure to check the corn for proper moisture content.
- ✓ **DO NOT BURN “TREATED” SEED CORN IN YOUR FURNACE.** Seed corn is treated with chemical pesticides that are harmful or fatal if swallowed; therefore, seed corn is dangerous to have in the house, especially where children can reach it. **Burning treated seed corn in your furnace will void the warranty and will destroy the exhaust system on the unit.**
- ✓ **Corn must be 14% or less moisture content.** Wet corn will cause rapid plugging and deterioration of the stove and exhaust system, lower the heat output and could void the product warranty due to rusting and improper operation of the appliance.
- ✓ Corn must be cleaned and free from debris. Corn right from the field will often have stalks, sticks, bolts and cob debris, which can plug the auger and/or cause damage to the auger and motor. Damage caused by dirty corn and other foreign objects is not covered by the product warranty. Ask for clean corn when you purchase it from your local corn supplier. Clean corn can be purchased in bulk or bagged from most elevators, feed stores or even your local farmer.

ALWAYS ASK FOR CORN WITH 11-12% MOISTURE CONTENT

- ✓ There are many varieties of corn grown around the world. Each variety has unique characteristics including the shape and size of the kernel. Your furnace will burn more consistently with a small to mid-size kernel corn.

If the kernel size of the corn varies greatly or if you switch sources frequently, you will get a less consistent burn, which will require more attention to the draft setting on your furnace. Therefore, purchasing corn from the same source will help achieve a more consistent burn.

There can be dramatic changes in heating ability depending on fuel quality, test weight and moisture content. BTU/h value can drop 25-60 percent using high moisture fuel, improper venting, improper installation, improper fresh air and poor maintenance practices.

DO NOT USE CORN WITH A HIGH WAX CONTENT!

OTHER AGRICULTURAL RATED FUELS:

Your Magnum furnace will burn a variety of agricultural fuels such as switch grass, oats, wheat, barley and rye. It is important to work with your local dealer on how to burn these fuels as you will have to burn on lower heat settings due to the smaller kernel size and burning nature of the fuels. If you are having trouble burning other fuels consult your dealer.

WOOD PELLETS

- ✓ As with corn, be consistent in your pellet supplier. Pellets will vary in content and burn characteristics from supplier to supplier. A consistent supply of pellets will require fewer adjustments to the draft of the furnace.
- ✓ Mixing Corn with the Wood Pellets can be done and will provide a little less heat in the spring and fall. Also, if the Corn is a little wet, mixing pellets in will help the fire maintain especially on the lower settings.
- ✓ Check your pellets for foreign objects. Your furnace warranty will not cover damage done to your furnace due to foreign objects in the fuel supply.
- ✓ Store your pellets in a dry place to prevent them from absorbing excess moisture.
- ✓ Vacuum the hopper out after every 6-7 bags to eliminate buildup of sawdust. More often if the pellets are poor quality. If sawdust is a problem you will have to screen each bag of fuel for a consistent feed.
- ✓ Wood pellets vary from supplier to supplier in ash content from less than 1% to 3% or more. Low ash content pellets will allow you to burn the furnace longer between cleanings. Only wood pellets manufactured to the Association of Pellet Fuel Industries (A.P.F.I.) standard for residential pellets fuels are recommended. Look for A.P.F.I. registration number on the back of pellets. Consult your local **Magnum** reseller for more information on approved wood pellet fuel.
- ✓ It is recommended not to store fuel over the summer months. Plan your fuel supply so that you use up the fuel by the end of the heating season. Pellets left over the summer can draw moisture and cause excessive ash in the system or plug the auger.

CLEARANCE TO COMBUSTIBLES

| CLEARANCE TO COMBUSTIBLES | | | |
|---------------------------|-----|---------------|----|
| Back | 1" | Supply Plenum | 2" |
| Side | 1" | Class L Vent | 3" |
| Corner | 1" | | |
| Front | 48" | | |
| | | | |

Do not hook into a chimney servicing another appliance.

You must make sure that when using an old chimney as a chase way access, that the chimney is in proper condition.

Have a certified chimney sweep inspect the chimney before using.

This installation is acceptable only if there are no other appliances hooked in and the venting goes all the way out the top of the existing chimney.

4" diameter venting recommended

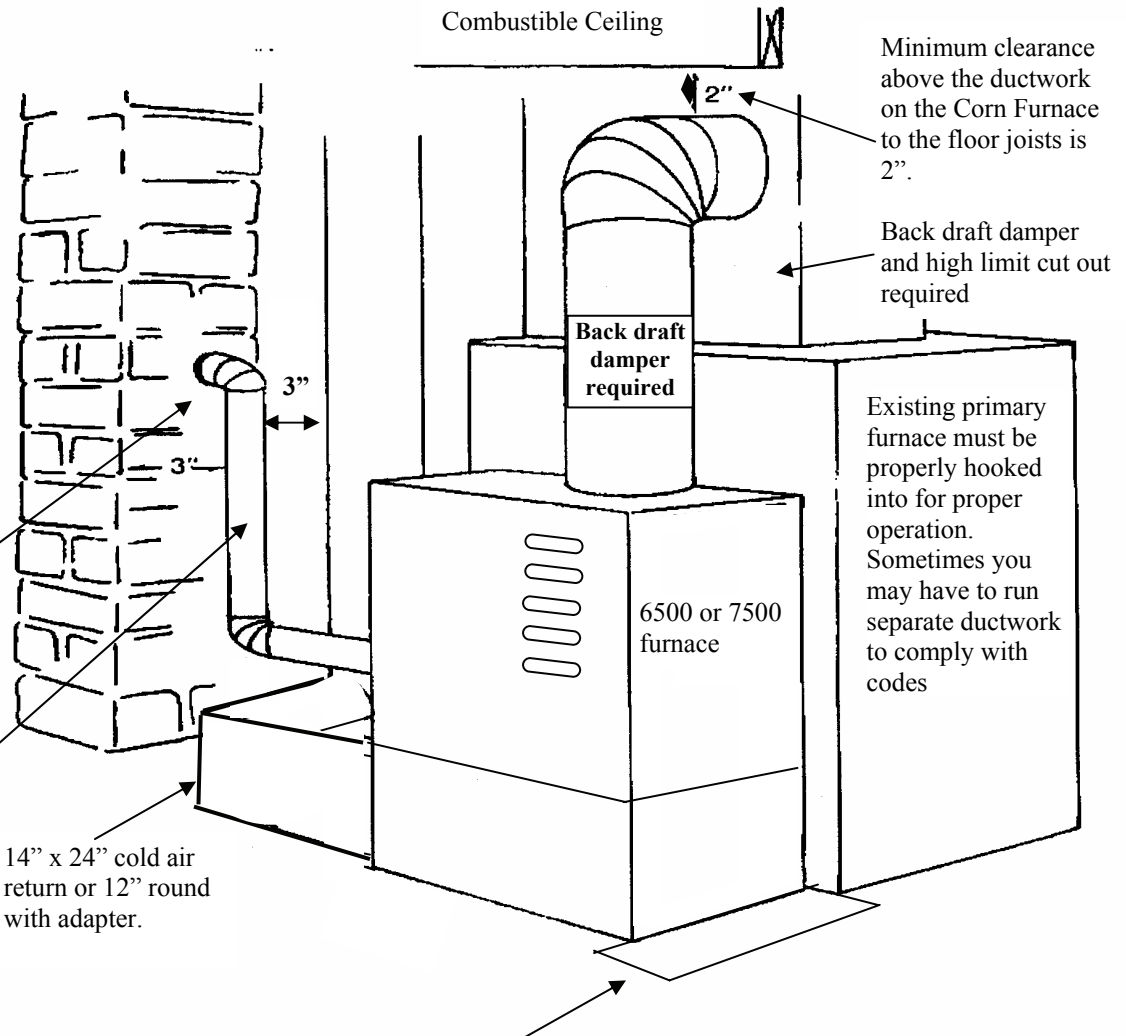

Minimum clearance above the ductwork on the Corn Furnace to the floor joists is 2".

Back draft damper and high limit cut out required

Existing primary furnace must be properly hooked into for proper operation. Sometimes you may have to run separate ductwork to comply with codes

14" x 24" cold air return or 12" round with adapter.

Floor protection must be provided because of possible spillage of ashes and burning fuel. There must be non-combustible materials placed 6" in front of and 6" to the side of the fuel loading and ash removal doors. If the unit is setting on a cement floor no protection is needed. Consult your local dealer for possible sources for non-combustible materials acceptable to be used.

FLOOR PROTECTION

The **Magnum 6500/7500 Corn/Wood Pellet Furnace** may be installed on a combustible floor, with proper floor protection, or on a masonry hearth. The hearth or non-combustible floor protector must extend a minimum of (6) six inches in front of and (6) six inches from each side of the ash removal door. It is recommended that the unit be placed on a non-combustible surface.

It is a good idea, but not required, that you place the unit up on a (4) inch high raised surface to keep it out of water, etc that may collect on the floor.

CLEARANCES TO COMBUSTIBLES

The furnace must be installed with the following minimum clearances to side and back wall combustible materials. **NOTE:** These are minimum clearances to combustible walls established by the testing lab. The amount of room needed on the left side of the unit to access the electrical panel is (6) six inches. When venting straight out the back of the unit, the B clearance is 1". C clearance is for a vertical vent install.

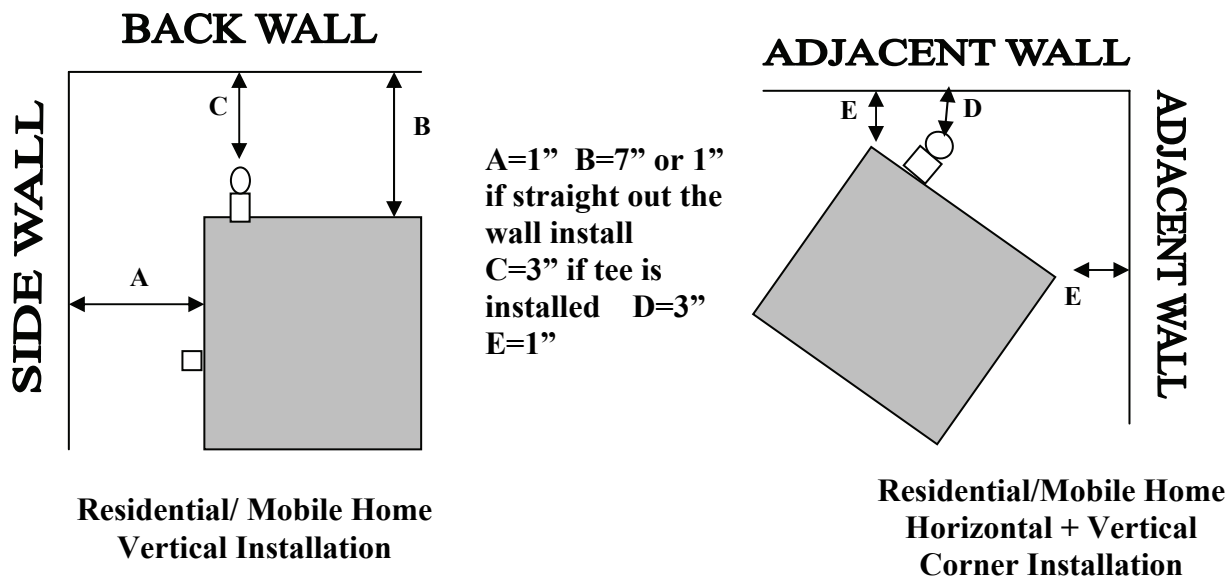

It is highly recommended that you have 2 feet clearance around the unit for servicing and maintenance. Both the left and right sides of the unit have panels that are hinged and will need to be opened periodically to clean, inspect or replace motors and parts.

If there is not room to have this much clearance you must leave 2-3 feet of clearance on the back of the unit. If the back panel is taken off, the motors can be accessed and removed.

IMPORTANT: Make sure that there is ample room to remove the unit if extensive service work needs to be done. Also there must be adequate room on the side of the furnace to load the fuel into the hopper.

If the room that the furnace is going to be in is small and also closed off, you will need to plan adequate ventilation to get the radiant heat out of the room. Having a 8 x 12 register in the lower and upper area of the wall or door will be adequate ventilation.

GUIDELINES FOR EXHAUST VENTING SYSTEMS DESIGN

It is required that only authorized licensed installers install your Magnum furnace. The following installation guidelines must be followed to ensure conformity with both the safety listing of this furnace and to local building codes.

NOTE: We recommend that you use listed Type PL “CORN Rated” venting to assure long life and tight seal.

- ✓ A listed 3” or 4” (4” required on 6500, recommended on 7500) type “PL” Corn vent exhaust system must be used for installation and attached to the pipe connector provided on the back of the stove. Use a 3” to 4” adapter for the initial pipe. A cap must be used at the termination of type “L” vent chimneys.
- ✓ Do not terminate vent in any **enclosed or semi-enclosed** area, such as; carports, garage, attic, crawl space, under a sundeck or porch, narrow walkway or closed in area, or any location that can build up a concentration of fumes such as a stairwell, covered breezeway etc.
- ✓ Vent surfaces can get hot enough to cause burns if touched by children. Non-combustible shielding or guards may be required. **Do not install a flue damper in the exhaust vent of this unit.**
- ✓ Termination must exhaust above air inlet elevation. **It is highly recommended that at least 5 ft. of vertical pipe be installed when the appliance is vented directly through a wall or in a basement.** This will create some natural draft to prevent the possibility of smoke or odor during appliance shutdown and to keep exhaust from causing a nuisance or hazard from exposing people or shrubs to high temperatures. In any case, the safest and preferred venting method is to extend the vent through the roof. **Do not connect this unit to a chimney flue serving another appliance.**
- ✓ Distance from doors and windows, gravity or ventilation air inlet into building:
Not less than 4 ft. / 1.2 m below, 4 ft. / 1.2 m horizontally from, 1 ft. / 305 mm above (This does not apply if the Windows are non-opening or have been fixed so they cannot open.)
- ✓ Distance from bottom of termination and grade – 1 ft. / 305 mm minimum. This is conditional upon the plants and nature of grade surface. The exhaust gases are not hot enough to ignite grass, plants or shrubs located in the vicinity of the termination. The grade surface must not be a lawn. Distance from bottom of termination and public walkway is 7ft. / 2.1m minimum.
- ✓ Distance to combustible materials – 2 ft. / 610 mm. This includes adjacent building, fences, protruding parts of the structure, roof overhang, plants and shrubs, etc.
- ✓ It is recommended that a single or double clean-out “tee”, for cleaning the vent in both directions, be installed at every 90⁰ junction to enable collection of fly ash and to permit periodic cleaning of the exhaust system. 90⁰ elbows accumulate fly ash and soot thereby reducing exhaust flow and performance of the furnace.
- ✓ Total length of horizontal vent must not exceed (10 ft.) / 3,000 mm. All joints in the vent system must be fastened by at least 3 screws, and all joints must be sealed with RTV silicone sealer to be airtight.
- ✓ When venting into an existing masonry or factory built chimney, the chimney must be cleaned, with all creosote removed. The chimney must be a type suited for solid fuel. **WARNING:** The chimney and the chimney connections must be kept clean and in good condition. **Venting must extend to the outside of the existing chimney.**
- ✓ The “PL” vent or single wall stainless exhaust system must be installed so as to be GAS TIGHT! The vent manufacturer’s installation procedures must be followed. In addition, pipe connections, joints and all pipe seams within the home should be sealed with high temperature RTV silicone sealer.
- ✓ If the furnace is to be installed into an unlined masonry chimney, it is necessary that a 4” stainless steel pipe be extended to the top of the existing chimney. The top of the existing chimney should be sealed with a steel plate (see diagram on page 17).

GUIDELINES FOR EXHAUST VENTING SYSTEMS DESIGN, CONT.....

- 1) Determine the “equivalent pipe length” for each component used according to the comparison chart below. Add the “equivalent pipe length” of all components to get the “total equivalent pipe length”.
- 2) Determine the altitude at which you are installing the stove.
- 3) Cross-reference the “total equivalent pipe length” and the altitude using the graph below.

NOTE: The “total equivalent pipe length” should not exceed 30-35 feet.

| Component | Equivalent Length | Equivalent Pipe Length | | | |
|--------------------------|----------------------------|------------------------|---|-------------|---------------|
| | | | = | | |
| Horizontal Straight Pipe | Actual Length in ft. x 1.0 | Horizontal Pipe | = | 1 x (2+1) = | 3 ft. |
| Vertical Straight Pipe | Actual Length in ft. x 0.5 | Vertical Pipe | = | 0.5 x 8 = | 4 ft. |
| 90° Elbow or Tee | 5.0 feet | 90 Degree Tee | = | 2 x 5 = | 10 ft. |
| 45° Elbow | 3.0 feet | 45 Degree Tee | = | 1 x 3 = | 3 ft. |
| | | TOTAL | = | | 20 ft. |

NOTE: These are guidelines only. Proper venting is accomplished by design and common sense. In most installations 4 inch diameter venting is recommended. If it does not vent properly you will have to change the venting to 4” if 3” diameter venting does not perform properly. It is the responsibility of the installer to determine proper venting operation of the furnace. If the proper venting and combustion air balancing is not achieved, the furnace will burn dirty, have a tendency to have the fire go out inconsistently and will cause the unit to plug up the heat exchangers and back areas of the appliance. If the heat exchangers and back heat exchangers are plugged and it causes the tubes to burn through or the heat exchanger to break, this is not covered under warranty.

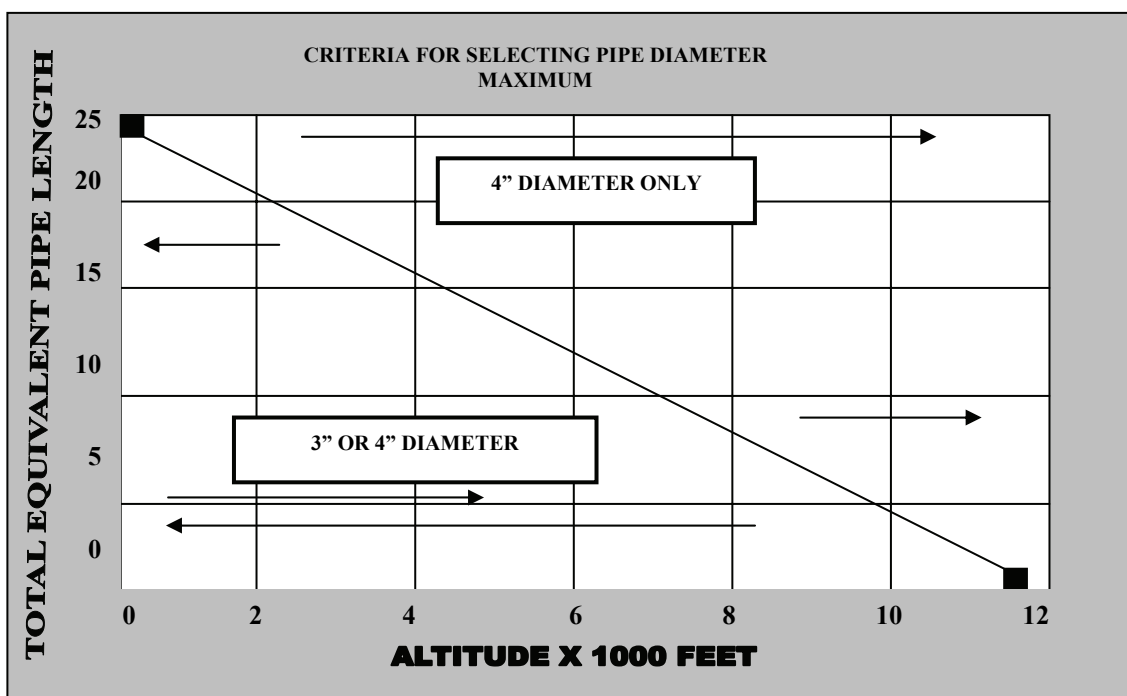

CHIMNEY AND VENTING (4" diameter is recommended)

Chimney required for the Magnum Corn Furnace is 3 or 4" (4" required on 6500) Class "L" (also known as PL vent). A starting collar must be used to attach the venting system to the furnace. When connecting into a Class "A" or masonry chimney an approved 3 or 4" liner MUST be used to prevent back drafting of the chimney.

EXISTING CLASS "A" CHIMNEY:

Run 3" or 4" Class "L" venting from the furnace connection to a positive connection with the class "A" chimney. AN APPROVED 3" or 4" LINER MUST BE USED IN CLASS "A" CHIMNEYS. Make sure each joint is firmly locked in place. Make sure the attachment of Class "L" to the Class "A" chimney is secure with sheet metal screws. Seal all joints with high- temperature silicone. Class "L" venting should maintain a pitch on rise from the furnace to the chimney of at least 1/4" per foot. .

- A): "L" Vent venting 3"or 4" B): "L" Vent elbow 90°, adj. 3" or 4" or Tee

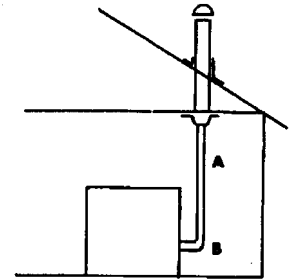

EXISTING MASONRY CHIMNEY: Run 3"or 4" Class "L" venting from the furnace connection to a positive connection with the masonry chimney. Make sure each joint is firmly locked in place. Make sure the penetration of the Class "L" venting into the masonry chimney is sound and secured with high- temperature cement. Seal all joints with high- temperature silicone. Class "L" venting should maintain a pitch on rise from the furnace to the chimney of at least 1/4" per foot.

AN APPROVED 3"or 4" LINER MUST BE USED IN MASONRY CHIMNEYS. Your new furnace is so efficient; an unlined chimney could remain cold and cause a downward pressure creating poor burning, incomplete combustion or back draft.

- A.)"L" Vent venting 3"or 4" B.)"L" Vent elbow, 90° adj. 3"or 4" or Tee

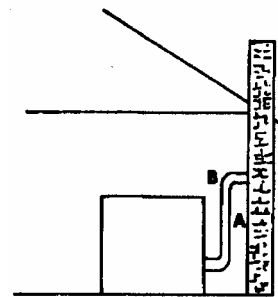

NEW VERTICAL INSTALLATIONS: Install 3"or 4" Class "L" venting and accessories according to manufacturers instructions and local codes (3" clearance to combustibles). Run Class "L" venting all the way from the furnace connection to point of termination. Make sure each joint is firmly locked in place. Seal all joints with high temperature silicone. Class "L" venting should maintain a pitch on rise from the furnace to the chimney of at least 1/4" per foot.

- A.) Vertical top 3" or 4" D.) Adj. flashing 3"or 4"
 B.) "L" Vent pipe 3"or 4" E.) Fire stop spacer 3"or 4"
 C.) Storm Collar 3"or 4" F.) "L" Vent 90° adj.3"or 4" clean out tee

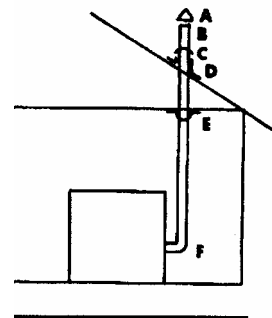

HORIZONTAL/VERTICAL VENTING: If venting the **Magnum**

Horizontally through an exterior wall, a vertical section needs to be installed to provide natural draft in the event of power failure.

Use only 3"or 4" Class "L" venting all the way from the furnace connection to point of termination. Make sure each joint is firmly locked in place.

Seal all joints with high temp silicone. Max. horizontal run length - 10ft.;

Min. vertical length - 5 ft.

- A.) "L" Vent pipe 3"or 4" B.) Wall thimble 3"or 4" C.) "L" vent 3" or 4" cleanout "T"
 D.) "L" Vent pipe 5ft E.) Wall Bracket F.) "L" vent 90° elbow ."
 G.) "L" vent Termination collar 3" or 4"

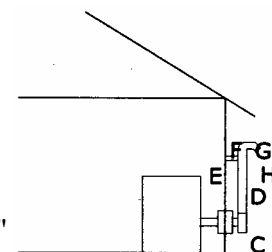

If installing the venting on the exterior of the home or shop, the venting must be enclosed in an insulated chase to prevent condensation and creosoting.

DIRECT VENT HORIZONTAL TERMINATION IS NOT RECOMMENDED

DESIGN GUIDELINES FOR OUTSIDE COMBUSTION AIR CONNECTION

OUTSIDE MAKE-UP AIR FOR COMBUSTION IS REQUIRED ON ALL INSTALLATIONS

- 1) For all Furnace installations, it is **REQUIRED** that the furnace combustion air intake be connected to a fresh air intake outside. If the home is newer or has been tightly insulated it is imperative to the operation of the unit to install outside combustion air and also have makeup air provided for the home. It is the responsibility of the installer and homeowner to determine and achieve proper balancing of fresh air for the home and for the appliance. If proper balancing of the fresh air is not achieved the furnace will not be able to operate correctly and serious damage to the heat exchangers will happen.
- 2) Connection to outside the house is **REQUIRED** for mobile home installations.

90 DEGREE BEND TERMINATION

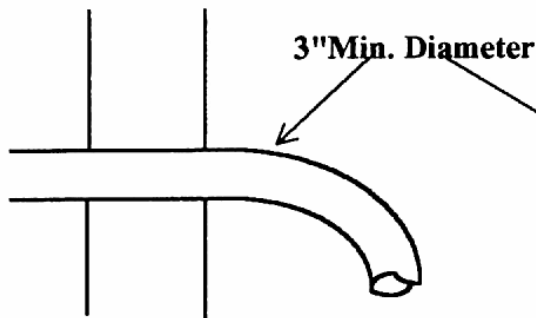

WIND HOOD TERMINATION

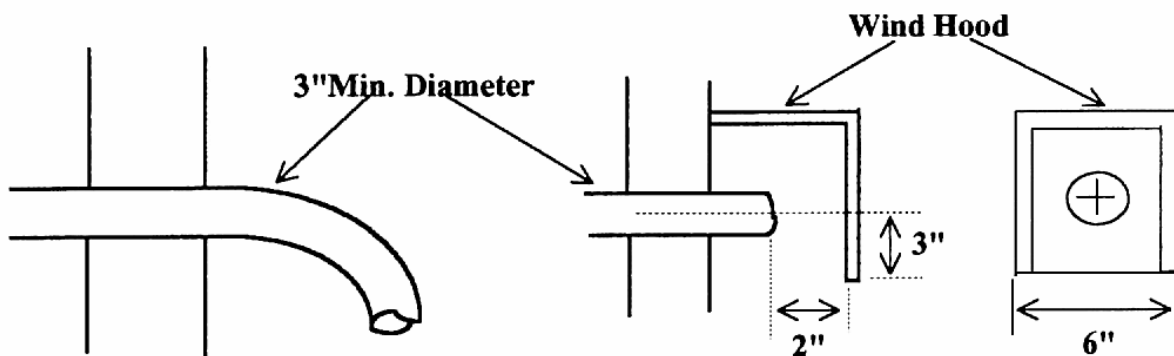

- 3) Fresh-Air pipe 3-4 inches in diameter (4" is recommended on 6500) is approved to use for outside air connections (straight or flexible). PVC pipe is allowed. You might need to use 6" diameter fresh air piper if the run is over 10 feet long.
- 4) When air inlet is connected to the outside, it **MUST** be terminated with a vertical 90-degree bend (down) or with a wind hood. Failure to do so could result in a burn back during high winds blowing directly up the air inlet during a simultaneous power failure (see diagram above).
- 5) It is important not to terminate the inlet of the fresh air intake too close to the venting outlet for the smoke. It is recommended that the inlet for the fresh air is a minimum of 3 feet away from the venting outlet and at least 1-2 feet below.
- 6) Blockage, excessive length, or bends in the air intake pipe will starve the furnace of combustion air. A 90-degree bend is equivalent in restriction to approximately 30 inches of straight inlet pipe. **Use 4" diameter fresh air intake to alleviate these issues.**
- 7) Furnace must have fresh air (oxygen) to perform properly. Incomplete combustion is caused by negative pressure in the home when the furnace is starved for fresh air. This causes carbon monoxide (CO) and can be dangerous. Provisions for outside air must be made and kept clean and free from blockage outside the home.

INSTALLATION CONFIGURATIONS

The Magnum 6500/7500 Corn/Wood Pellet Furnace may be installed as follows:

- 1) A Stand-Alone System (Shop Furnace with ductwork coming off the top of the unit)
- 2) A Supplementary (secondary) heating system (Add-On Furnace)
- 3) A Central heating system (independent duct work) **Note: Recommend additional primary heat source (Most building codes and insurance codes require a primary heat source in addition to a solid fuel appliance. The home owner accepts all responsibility if they install the Magnum furnace as their sole source of heat.**

The Magnum 6500/7500 Corn/Wood Pellet furnace is not intended to be used as a SOLE heat source.

WARNING
DO NOT INSTALL IN SLEEPING ROOM
UNIT MUST BE INSTALLED BY A LICENSED,
CERTIFIED/ FACTORY TRAINED INSTALLER

Horizontal Exhaust Direct Vent Termination instructions:

- 1) Locate proper position for the type “PL” wall thimble. Use a saber saw or key-hole saw to cut a 7 ¼-inch (for 3” vent) or a 8 1/4-inch diameter hole through the wall (G) for a 4-inch pipe. Install the wall thimble in the hole. **NOTE: The size of the hole will be determined by your wall thimble.**
- 2) Position unit in place leaving plenty of room for servicing the unit. Push the type “PL” pipe through the wall thimble. Squeeze a bead of high temperature RTV silicone sealer around the outside of the 3” or 4” diameter exhaust pipe approximately ½” from the stove back panel (unless using the Pipe Adaptor). Firmly push on a section of type “PL” pipe until the inner pipe liner pushes up against the bead of RTV sealer or attach the pipe adaptor with a 3” hose clamp and lock the “PL” vent clean out tee or elbow onto the pipe adaptor. Don’t seal the entire 3” diameter pipe as you will not be able to disassemble the pipe at a later date. The bead of silicone will act as a gasket right on the end of the 3” pipe (D). **Alternate Method:** An approved type “PL” connector (pipe adaptor) may be used to allow easy disconnect for maintenance. (The RTV sealant must be used in mobile home installation)
- 3) Attach all venting, clean out tees or elbows and straps into place.
- 4) **NOTE:** Make sure that you leave enough clearance between the wall, sides and the back of the unit so that when you open the hopper lid you will be able to load fuel
- 5) Install type “PL” termination cap with rodent screen cap (optional) on outside end of pipe. **Note:** The end of the exhaust pipe must extend a minimum of 12 inches from the outside of the building. Rodent screen cannot be less than 3/8” opening mesh.
- 6) When installing combustion air from outside, cut a separate hole through the wall for the fresh air tube. This tube must be 3” minimum diameter only. Connect outside air pipe inlet on stove. This tube must be terminated with a 90 degree elbow or hood. Care must be taken not to interfere with the operation of the combustion-air draft damper. Always make sure that it moves freely.

NOTE: It is not recommended to install vertical venting on the outside of the wall without enclosing the venting in an insulated chase way.

Whenever possible run the venting on the interior.

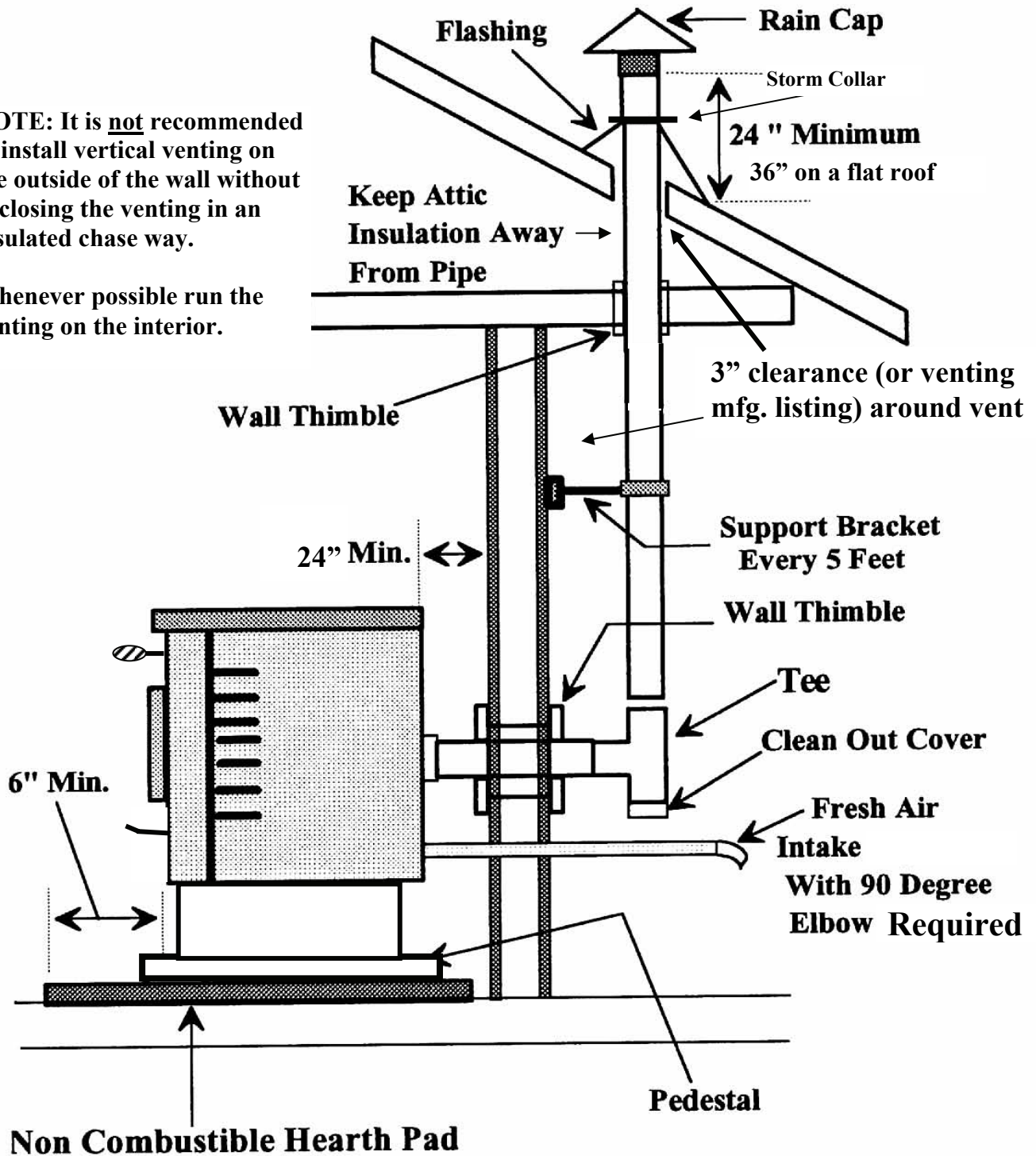

THROUGH THE WALL, VERTICAL PIPE INSTALLATION WITH TERMINATION THROUGH THE ROOF

WARNING: Improper operation of the unit and Creosoting will occur if exterior venting is not enclosed in an insulated chase way.

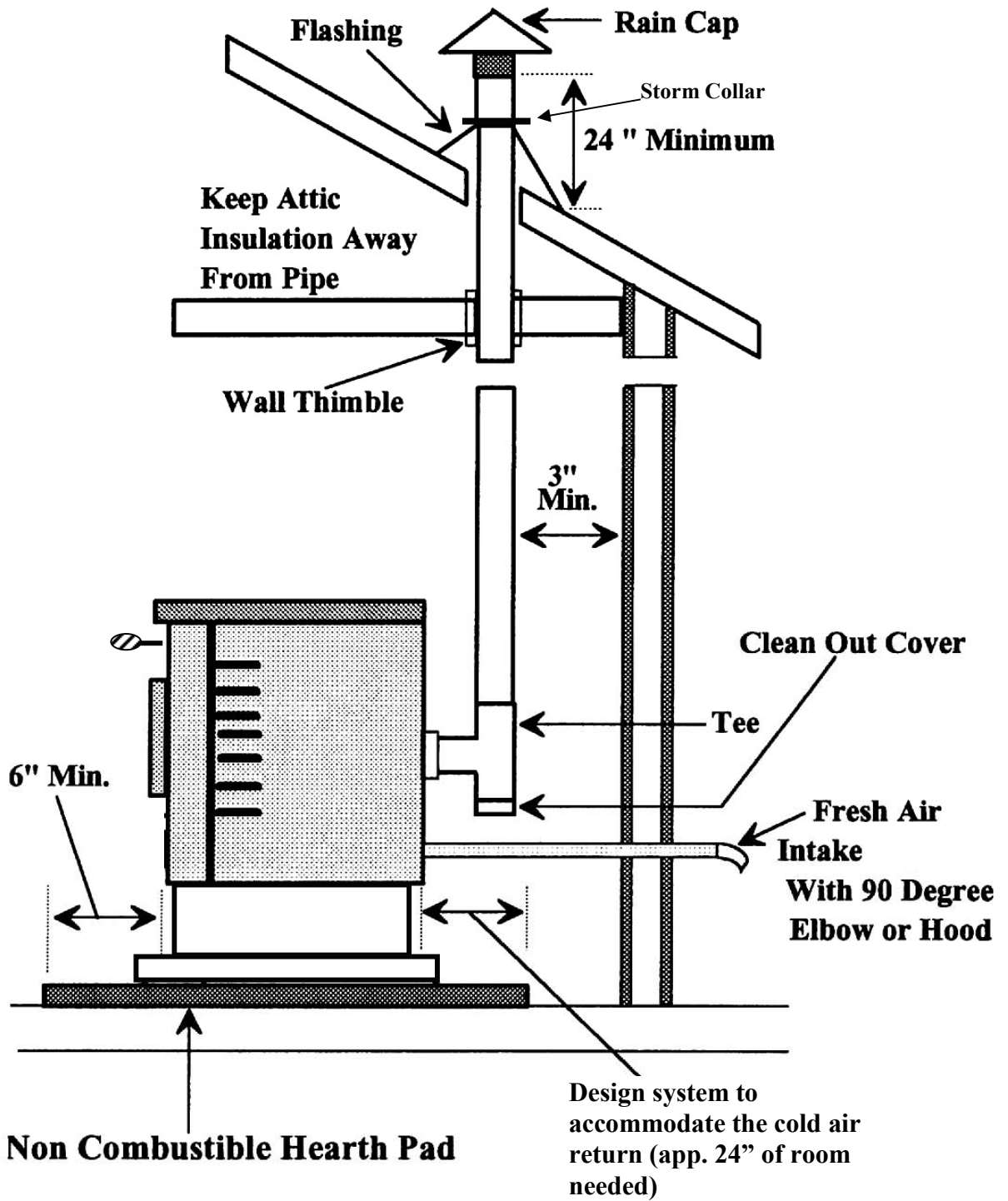

INSIDE VERTICAL PIPE WITH ROOF TERMINATION

DUCTING

STAND ALONE OR SHOP FURNACE INSTALLATION

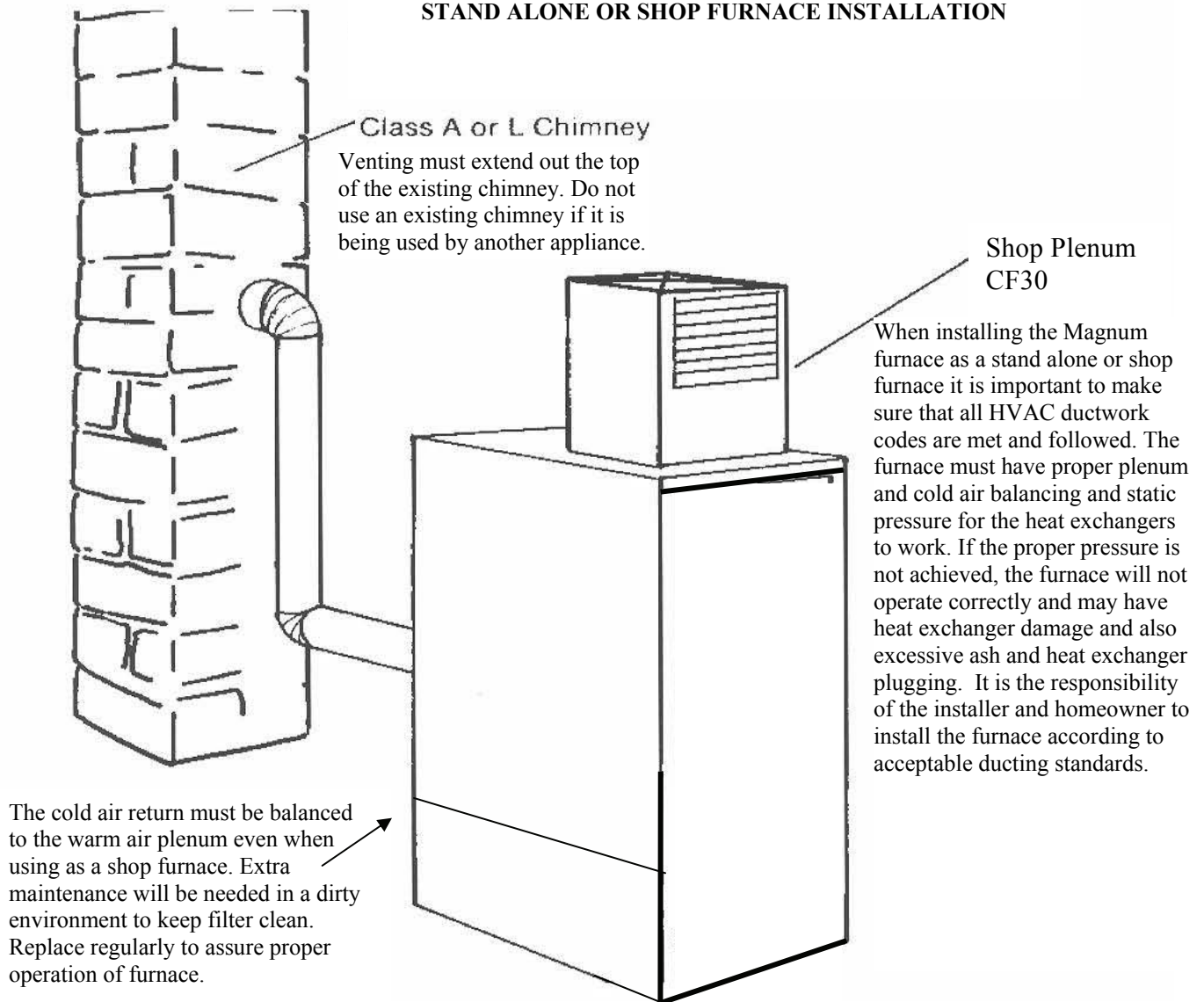

STAND ALONE OR SHOP FURNACE

The Magnum 6500/7500 Corn/Wood Pellet Furnace may be installed as a stand-alone system as long as the unit is in a non-confined area. An unconfined space would be an area with 8' ceiling height minimum and 650 square feet minimum open floor space. Fresh Air for combustion would have to be connected directly to the furnace and adequate infiltration for dilution and distribution of supply and return air would have to be provided.

When installed in a garage, the unit must be installed so that the burners and ignition source are located not less than 18 inches above the floor and the furnace must be located or protected to avoid physical contact and damage from vehicles.

Never store combustible materials in proximity of furnace or leave materials in contact with the furnace that may combust or impede airflow.

Attach the shop Plenum (CF30) to the outlet on top of the unit. The return air intake and filter system are already in place. Complete venting, chimney, electrical and thermostat installation as per the appropriate section of this manual.

DUCTING

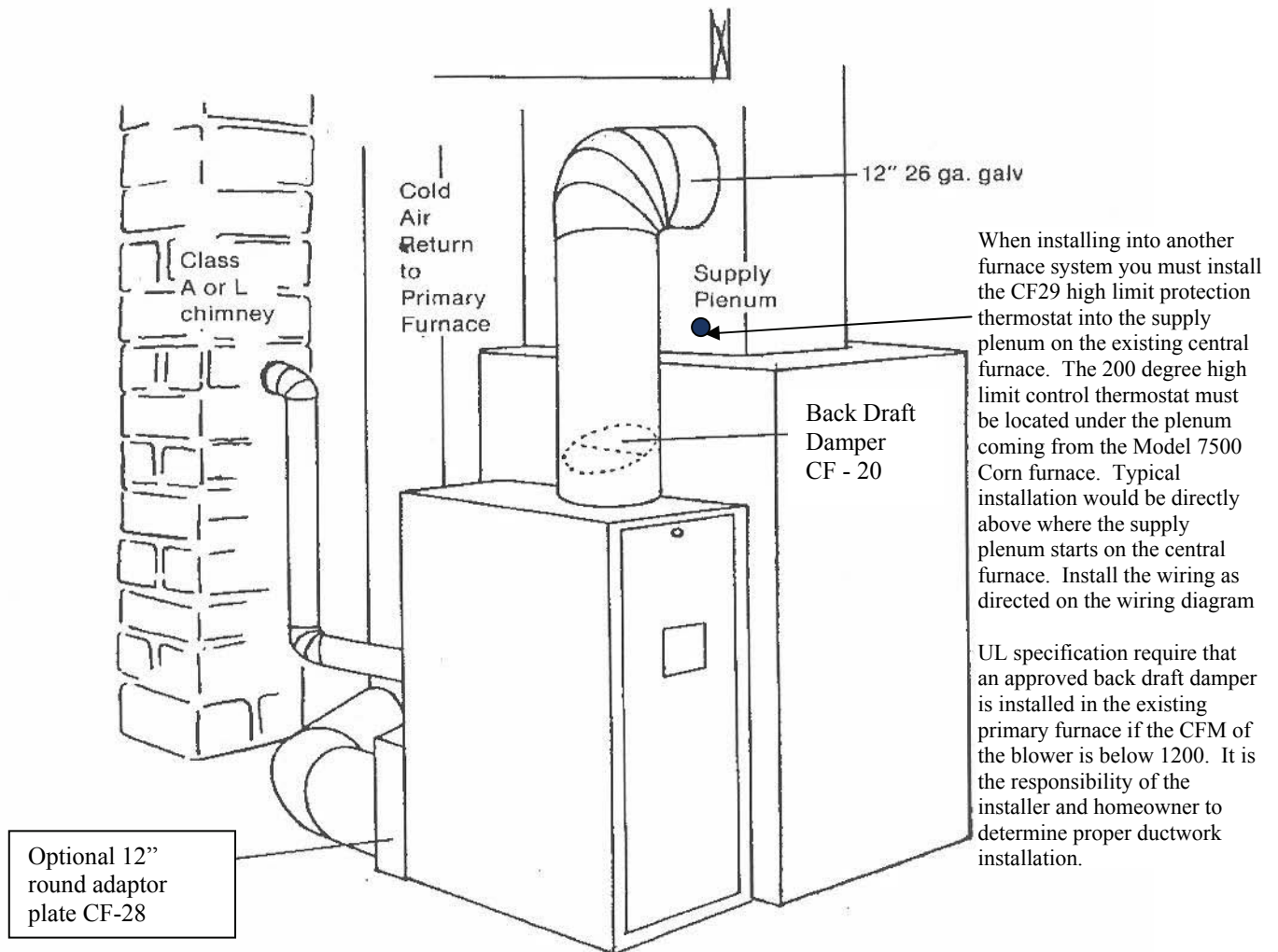

Add-On Furnace (Supplementary Heat installation)

To install the Magnum 6500/7500 as an "add-on furnace" first set the unit along side the existing primary forced-air up flow furnace and position so that all maintenance and operational functions can be performed.

Attach the section of ducting that will have the fan-limit control installed in it and then install the back draft damper (CF20). This prevents air from the existing furnace from blowing back into the Magnum furnace and causing damage to the electrical system when the Magnum is not in use. Install the 12" round 26 gauge galvanized ducting, elbows, etc. up and into the existing supply plenum. Next, connect the cold-air return ducting. A minimum of 12" round must be used for the cold-air return. Determine the size required for this installation and attach to the back of the filter panel. **Order part # CF28 to convert cold air return from rectangular to 12" round.**

Return air is very important to the furnace operating properly. Adequate heat distribution will not happen if the return air is not hooked up or adequate. **Failure to supply adequate return air will void the warranty on the furnace.**

Complete the venting, electrical and thermostat installation as per the instructions in this manual.

DUCTING

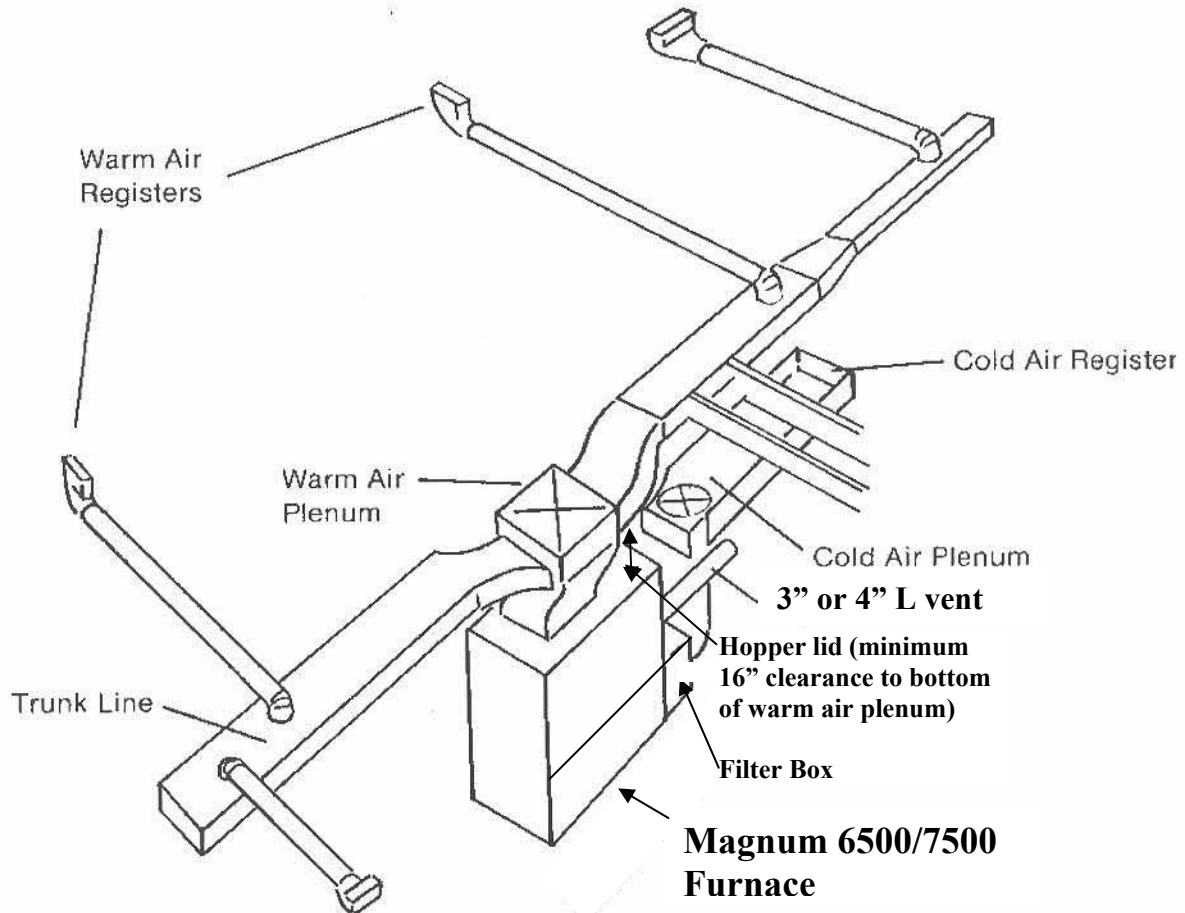

Installation configuration when using the Magnum 6500/7500 furnace as an independent ductwork installation separate from the existing primary furnace. The Magnum Furnace is not intended to be installed as the sole source of heat and is not allowed to be the sole source of heat in most states and building/ insurance codes.

To install The **Magnum with independent ducting** first locate the furnace as near the chimney and as centralized with respect to heat distribution as practical. Follow all clearance to combustibles requirements. Connect the ductwork to the furnace. Minimum supply plenum size: 14" x 14", minimum return plenum size: 12" round. When a furnace is installed so that supply ducts carry air circulated by the furnace to the areas outside the space containing the furnace, the return air must also be handled by a duct sealed to the furnace casing and terminating outside the space containing the furnace. Where there is no complete return duct system, the return connection must be run full size to a point outside the furnace room. Air duct systems should be installed in accordance with standards for air conditioning systems. NFPA Pamphlet #90. They should be sized in accordance with ACCA Manual D or whichever is applicable, after completing installation as per the appropriate section of this manual.

Make sure that when the warm air plenum is installed that there is adequate room to open and load the hopper lid. Place furnace so that maintenance and operation of the unit can be performed.

GLASS MAINTENANCE, ADJUSTMENT, REMOVAL AND REPLACEMENT

Your **Magnum 6500/7500 Corn/Wood Pellet Furnace** comes to you with the glass door installed in place, ready for use. The glass is surrounded on the edges with a gasket and seated in a glass channel. It is held in place with two (2) clips on the top and (2) clips on the bottom

REMOVAL OF BROKEN OR DAMAGED GLASS

Open the door and lift off of hinges. If the door is tight, tap gently on the bottom of the door with your hand or rubber hammer. Lay door down on newspaper with glass clips facing you. Using a #2 Phillips screwdriver, loosen the screws and take off the glass clips. Remove the broken glass carefully and discard.

Check to make sure that the gasket material under the glass is in good shape. You can get this material from the factory or from an authorized **Magnum** reseller if it needs to be replaced.

Reverse the above procedure for replacing new glass. **When installing the new glass make sure that the glass is not sitting binding or hitting any corners. If the glass touches any of the casting when tightening it will break.**

WARNING

**Do no operate unit with broken glass.
Do not substitute original factory glass.
You must use only factory authorized glass:
(8.680" x 15.125" high temperature Ceramic glass, 5mm thick)
Do not slam door shut.
Do not strike glass.
Do not use abrasive cleaners.
Do not clean when glass is hot.**

CLEANING THE GLASS

When the fire is first started, it will produce some smoke. The smoke might accumulate on the glass surface. Before the fire gets hot, open the door and wipe the glass surface off with a damp rag. Do not touch the surface with your hands. If after constant use, the glass is dirty; you must clean the glass so that it will not become etched with the fly ash. When the glass has cooled off, take a damp rag, put a little fly ash from the unit on it and clean the glass. If this does not clean the glass use a special glass cleaner provided by your **Magnum** reseller. **We have found that Amway crème glass & chrome cleaner works real well.**

**Glass Spacer Clip
One each side**

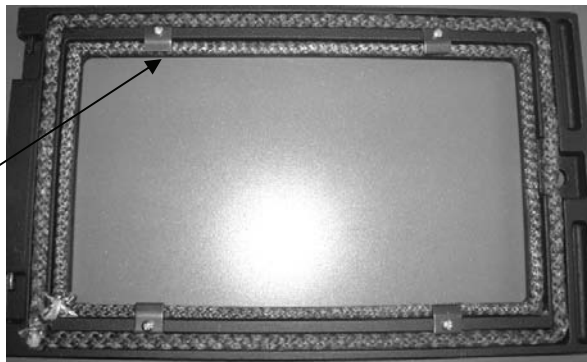

STOVE CONTROLS

Front view

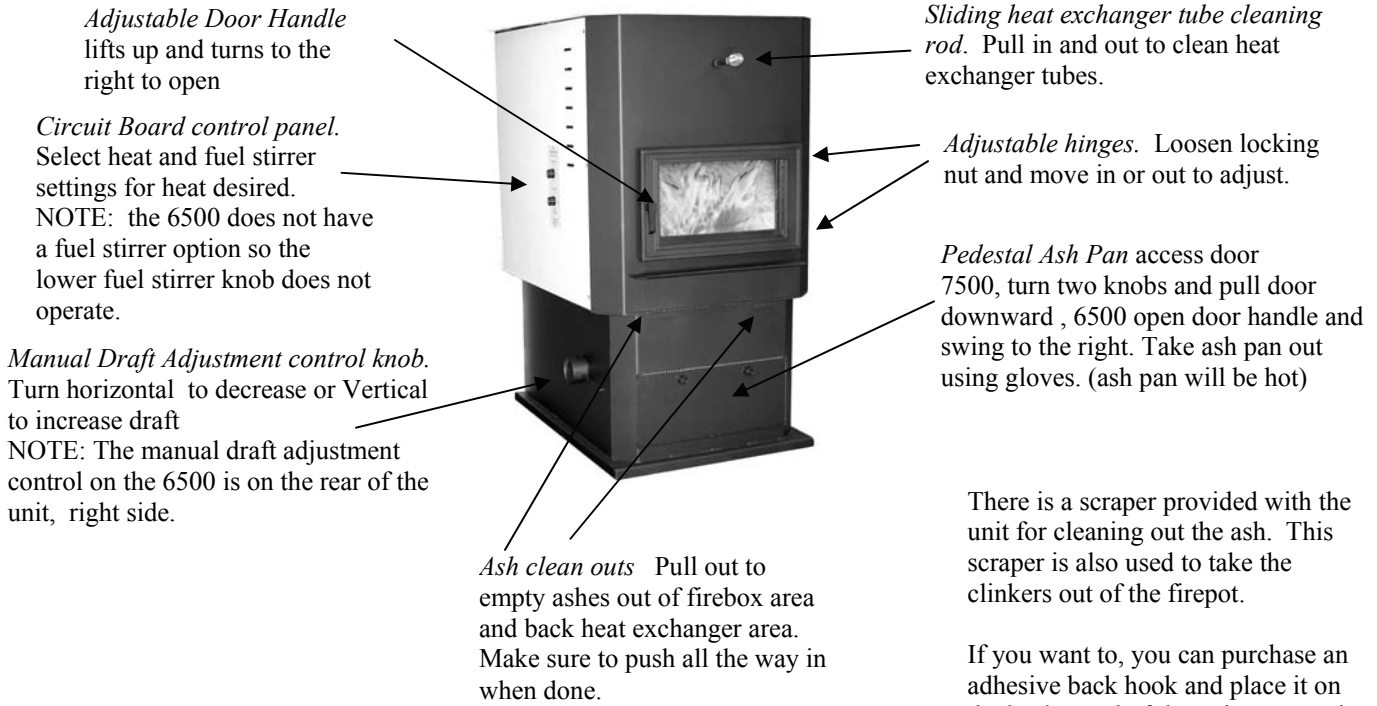

There is a scraper provided with the unit for cleaning out the ash. This scraper is also used to take the clinkers out of the firepot.

If you want to, you can purchase an adhesive back hook and place it on the back panel of the unit to store the scraper tool. This can be purchased at any local hardware store.

Side view showing heat exchanger rod operation

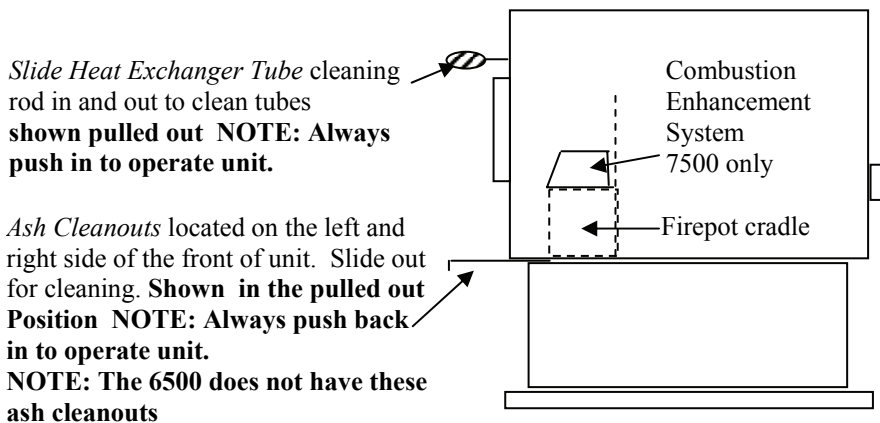

The combustion enhancement system sits on top of the Firepot (7500 only). When starting the fire use the scraper tool and remove the CES to expose the firepot. Make sure that there is not fuel or ashes on top of the firepot flange when re-installing the combustion enhancement system.

The combustion enhancement system does not have to be in place when operating the furnace. The 6500 does not have this system.

COMBUSTION ENHANCEMENT SYSTEM (CES)

The Magnum 7500 Corn and Wood Pellet Furnace comes standard with a combustion enhancement system built into the firepot. This system enables the unit to perform efficiently and reduces ash, fly-ash on the outside of the home and directs more heat to your home. **The 6500 does not have this option.**

It is important that whenever operating the Magnum 7500 that the CES is in place. You can however remove the CES for cleaning, maintenance and startup of the fire.

When starting the fire take the scraper tool (provided) and hook it into the top of the CES and Remove. Be careful not to burn yourself or set the hot CES on a combustible surface.

After you have lit the fire and the fire is established you can place the CES back on the firepot and the fire will start quicker.

NOTE: the fire may not be coming out the top of the CES right away but you will be able to see a glow indicating that the fire is burning. If you do not see any fire glow, remove the CES and check the fire.

It is important to always clean the surface area that the CES sits on. If the surface area is not clean, fire will come out between the CES and the firepot. This will not cause damage or problems but will not allow the CES to work efficiently.

Place scraper tool in front tab and
remove the CES

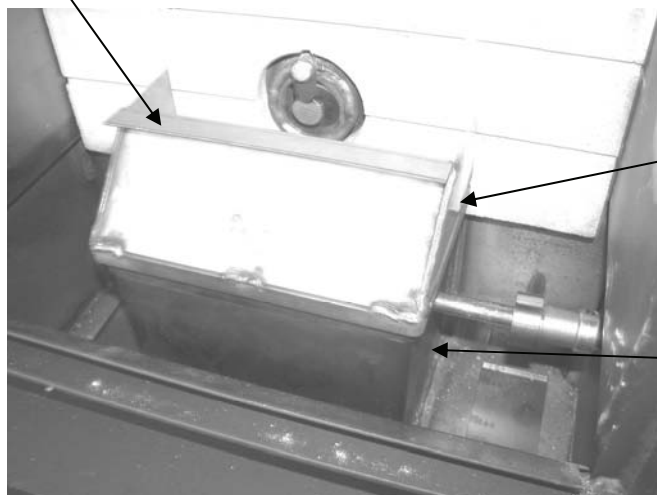

Combustion
enhancement system
(CES)

Firepot and
cradle

LIGHTING INSTRUCTIONS (7500 Furnace)

Before lighting your **Magnum 7500** for the first time make sure that all items are out of the hopper and firebox area. Turn the heat setting and fuel stirrer knob to the off position and turn the manual draft to 90 percent closed. **Note:** If using a wall thermostat option make sure that the thermostat is turned up above room temperature. The unit will operate on low fire if the thermostat is turned down. **Always start the fire on the # 3 heat setting. Open the Combustion Enhancement System. You will have to have the door open to hinge the CES toward the door opening.**

- ✓ Place a large handful of wood pellets or fire starter in the firepot.
- ✓ Squirt a small amount of fire starter gel on top of the wood pellets. (Evenly across the wood pellets)
- ✓ Light the fire starter and wait app. 1-minute for it to start burning.

- ✓ Turn the heat setting knob to the number 3 setting and turn the manual draft lever approximately $\frac{1}{4}$ open. (more or less if necessary)

- ✓ Turn the Fuel Stirrer knob to the number 1 setting and let it rotate a couple turns to stir the firestarter and wood pellets together. Then turn the fuel stirrer off until the fire is burning good. (approximately 1 minute)
- ✓ Close the Combustion Enhancement System.
- ✓ Once the wood pellets are burning good enough for the fuel stirrer to stay on (app. 1 minute), turn the fuel stirrer to the number 1 setting and leave it on. Adjust the manual draft lever (located on the left side of the unit to the left of the ash pan so that there is approximately $\frac{1}{2}$ inch of fuel in the bottom of the firepot. This level cannot be determined quickly. Minor adjustments will have to be made until the main fuel starts coming in and the unit is up to temperature.

- ✓ **NOTE: Even if you are burning corn or other fuels in your Magnum 7500; wood pellets make an excellent source of starter fuel. Corn takes too much starter gel to get lit and up to temperature. (DO NOT START THE FIRE WITH CORN)**
- ✓ Three minutes after the heat setting knob is turned to the number 3 setting the fuel will start to feed into the firepot. If the firepot begins to fill up with unburned fuel, open the manual draft lever a little to burn up the excess fuel. If the fire is going out because there is too much fuel coming in, turn the heat setting knob off and then turn back on. This will give you another 3 minutes before fuel feeds in.

- ✓ If the fire is burning too fast and the fuel is being burned up too quickly, turn the manual draft lever closed a little to slow the fire down. This should be done in small $\frac{1}{16}$ " increments so that the fire doesn't change too quickly.

- ✓ Once the fire has established itself (usually 10 to 15 minutes) adjust the manual draft lever so that there is approximately $\frac{1}{2}$ inch of fuel in the bottom of the firepot. **Do not let the fuel build up any higher than that or it will cause the fire to burn dirty and you will get excessive ash. If the fuel level is too low (below $\frac{1}{4}$ " the fire may go out. Once you have achieved this the fuel feed and air mixture should sustain the $\frac{1}{2}$ level.**

- ✓ **The Combustion Enhancement must be placed on top of the firepot before closing the door. The CES does not have to be used on top of the firepot for proper operation of the furnace.**

Damper Control Function

The damper control lever is located on the left side of the unit close to the ash pan access panel. You will turn the lever according to the air required. The knob serves as an indicator as to how far the air is open. The proper setting will vary from home to home so fine tuning has to be done in the home with the fuel that you plan to use. **Normally $\frac{1}{4}$ to $\frac{1}{3}$ open will be sufficient. When you are using the high setting, the air damper has to be adjusted independently and will have to be app. $\frac{1}{2}$ to $\frac{2}{3}$ open.**



CIRCUIT BOARD FUNCTIONS

Startup

When the circuit board is energized (unit plugged in) there is a 15 second purging of the auger tube to allow fuel to enter the firepot. To initiate the Startup, turn the heat setting knob to the number 3 setting. If the unit is started on the 1 or 2 settings the firebox temperature may not rise fast enough for the low limit sensor to engage. When the heat setting knob is turned on, the draft blower starts but the auger feed does not start feeding fuel until after 3 minutes.

The fuel stirrer can be turned on at this time and run for a couple of turns to stir the fuel. After the fuel is lit, the fuel stirrer can be left on the number 1 setting. Corn may require a higher setting if the moisture content is high or if the corn has a high starch content. Wood pellets may require a higher setting if the ash content is high or if you are running the unit on the high setting.

NOTE: Make sure that the wall thermostat is turned up so that the unit will start on the number 3 setting.

If the fire is not hot enough to engage the low limit sensor, (within 20 minutes) the circuit board will cycle through the shut down mode and the unit will shut down. The green indicator light will blink rapidly to show that the unit is not operating properly. To restart the system, simply turn the heat-setting knob to the off position and turn back on to the number 3 setting.

Once the unit is operating at the proper temperature (usually 10-15 minutes), select the heat setting that you want, adjust the manual draft adjustment lever so that the fuel is app. ½ inch thick in the bottom of the firepot. **(there should be a nice bed of red coals in the bottom of the firepot)**

The number 3 heat setting is best for corn and the number 4 heat setting is best for wood pellets for a high fire burn. The high heat setting should only be used if the home is over 2500 square feet or the weather is extremely cold. The high heat setting is intended for use with wood pellets and the highest heat setting for corn would be the number 4 setting.

The unit is not designed to be operated for long periods of time on the highest setting. Optimum efficiency is achieved by using lower settings. It is also recommended that the unit not be run for extended periods of time on the number 1 setting. The draft blower and venting will fill up with fly ash after a long period of time. Once a day turn the manual draft knob open all the way and turn the unit up on high. Run it this way for a few minutes to clear the venting and draft blower. It is good to run the unit on one of the higher settings at least once a week to clear the system and eliminate the buildup of fly ash.

Shutdown

To shut the unit down simply turn the heat setting knob to the off position and the system will enter the shut down mode. **The fuel stirrer, room fan and exhaust blower** will continue to operate until the low limit safety sensor tells it that the fire is out and the firepot has gone through its cleaning cycle. After this time the fuel stirrer will shut off. When this happens the fuel auger will go into the purging cycle and auger a small amount of fuel out of the auger into the firepot. Then the entire system shuts down.

Before starting up the Magnum 7500 Corn/Wood Pellet unit again, it is important to remember to shut off the fuel stirrer so that the fire can be started properly. It will also ensure that the fuel stirrer will not start with someone having his or her hand in the firepot area.

SETTING THE DRAFT (7500 Furnace)

A proper draft setting is crucial to the successful burning of solid fuels. Draft refers to the amount of air flowing through the burn chamber of your stove. Too much or too little draft will cause your furnace to burn improperly and may result in the fire burning out. Please follow these guidelines carefully as you operate your furnace to achieve maximum efficiency and value..

- ✓ The amount of draft required for your furnace to burn properly will depend upon your installation and the fuel you use. You can set your draft by looking at the flame and following these guidelines. The manual draft lever is the rod and knob to the left side of the ash door. Turning the lever towards the ash door increases the draft and turning the lever upright decreases the draft. A little movement of the lever goes a long way to changing the flame. It may take several trial and error adjustments on the draft to achieve the correct setting.
- ✓ The flame should be an “active” flame. A flame that moves around lazily and emits visible smoke needs more draft. To give the fire more draft, turn the lever counter-clockwise 1/8” and check the flame again. If the status of the flame has not changed, move the lever another 1/8” until you get a clean “dancing” flame. **If moving the damper does not change the fire, you might have negative pressure in the home. Consult with your Magnum 7500 installer.**
- ✓ The base of the flame should be blue in color and the top of the flame should be yellow.
- ✓ If the flame does not have enough draft, fuel will build up in the firepot and eventually smother the flame. If this happens, or if you notice the firepot is filling up with partially burned fuel, open the damper 1/8” at a time until the fire is clean and dancing.
- ✓ If the flame has too much draft, the flame will look like a torch in that it will be moving rapidly and blowing fuel out of the firepot. If you find that you have this condition, move the damper counter clockwise 1/8” at a time until the condition of the flame changes.

When you change fuel sources it may become necessary to readjust the damper control knob. You should not have to continually adjust the manual knob except when using the high fuel setting. The circuit board automatically adjusts the air to the firepot on the settings from 1 to 3.

LIGHTING INSTRUCTIONS (6500 Furnace)

Before lighting your **Magnum 6500** for the first time make sure that all items are out of the hopper and firebox area. Turn the heat setting knob to the off position. The manual draft should not have to be adjusted. **Note:** If using a wall thermostat option make sure that the thermostat is turned up above room temperature. The unit will operate on low fire if the thermostat is turned down. **Always start the fire on the # 1 or 2 heat setting. The #3 heat setting will flood the fire.** Place a large handful of wood pellets or fire starter in the firepot.

- ✓ Squirt a small amount of fire starter gel on top of the wood pellets. (Evenly across the wood pellets)
- ✓ Light the fire starter and wait app. 1-minute for it to start burning.
- ✓ Turn the heat setting knob to the number 1 or 2 setting and let the fire get established for about 20 minutes before placing on a higher setting. Adjust the heat selector to your heating requirements.
- ✓ You might need to stir the fire occasionally during startup to get the fire going really well. Opening the door will stop the fuel from feeding so do not leave the door open too long or the fire will go out.
- ✓ The manual draft adjustment located on the back right of the unit (right as you are looking at the front of the unit) may need to be adjusted from time to time to correct weather conditions. This adjustment should be able to be set and left alone. The system is designed to correct the fire for most conditions.
- ✓ **NOTE: Even if you are burning corn or other fuels in your Magnum , wood pellets make an excellent source of starter fuel. Corn takes too much starter gel to get lit and up to temperature. (DO NOT START THE FIRE WITH CORN)**
- ✓ Three minutes after the heat setting knob is turned to the number 1 or 2 setting the fuel will start to feed into the firepot. If the firepot begins to fill up with unburned fuel, open the manual draft lever a little to burn up the excess fuel, turn the heat selector to the number 1 setting or turn the heat selector off and then back on. If the fire is going out because there is too much fuel coming in, turn the heat setting knob off and then turn back on. This will give you another 3 minutes before fuel feeds in.
- ✓ If the fire is burning too fast and the fuel is being burned up too quickly, turn the manual draft lever closed a little to slow the fire down. This should be done in small 1/16” increments so that the fire doesn’t change too quickly.
- ✓ Once the fire has established itself (usually 15 to 20 minutes) adjust the manual draft lever so that the fuel does not build up in the firepot. The fuel load will change and cycle so do not make adjustments until you are sure that they are needed. The system automatically adjusts itself to compensate for the fire.

Fuel Stirrer option is not used on the model 6500 furnace. Leave this knob in the off position



Damper Control Function

The damper control lever is located on the back (right side) of the unit. You will turn the lever according to the air required. The knob serves as an indicator as to how far the air is open. The proper setting will vary from home to home so fine tuning has to be done in the home with the fuel that you plan to use. **Normally 1/2 to 3/4 open will be sufficient. When you are using the high setting, the air damper has to be adjusted independently and will have to be app. 1/2 to 2/3 open.**

CIRCUIT BOARD FUNCTIONS (6500 Furnace)

Startup

When the circuit board is energized (unit plugged in) there is a 15 second purging of the auger tube to allow fuel to enter the firepot. To initiate the Startup, turn the heat setting knob to the number 1 or 2 setting. When the heat setting knob is turned on, the draft blower starts but the auger feed does not start feeding fuel until after 3 minutes.

NOTE: Make sure that the wall thermostat is turned up so that the unit will start on the number 3 setting.

If the fire is not hot enough to engage the low limit sensor, (within 20 minutes) the circuit board will cycle through the shut down mode and the unit will shut down. The green indicator light will blink rapidly to show that the unit is not operating properly. To restart the system, simply turn the heat-setting knob to the off position and turn back on to the number 1 or 2 setting.

Once the unit is operating at the proper temperature (usually 10-15 minutes), select the heat setting that you want, adjust the manual draft adjustment lever so that the fuel is not building up in the firepot. **(there should be a nice bed of red coals in the bottom of the firepot)**

The number 3 heat setting is best for corn and the number 4 heat setting is best for wood pellets for a high fire burn. The high heat setting should only be used if the home is over 2500 square feet or the weather is extremely cold. The high heat setting is intended for use with wood pellets and the highest heat setting for corn would be the number 4 setting.

The unit is not designed to be operated for long periods of time on the highest setting. Optimum efficiency is achieved by using lower settings. It is also recommended that the unit not be run for extended periods of time on the number 1 setting. The draft blower and venting will fill up with fly ash after a long period of time. Once a day turn the manual draft knob open all the way and turn the unit up on the 4 setting. Run it this way for a few minutes to clear the venting and draft blower. It is good to run the unit on one of the higher settings at least once a week to clear the system and eliminate the buildup of fly ash.

Shutdown

To shut the unit down simply turn the heat setting knob to the off position and the system will enter the shut down mode. **The room fan and exhaust blower** will continue to operate until the low limit safety sensor tells it that the fire is out and the firepot has gone through its cleaning cycle. After this time the fuel stirrer will shut off. When this happens the fuel auger will go into the purging cycle and auger a small amount of fuel out of the auger into the firepot. Then the entire system shuts down.

Before starting up the Magnum 6500 Corn/Wood Pellet unit again, it is important to remember to clean out the firepot so that the fire can be started properly. It will ensure that the fuel will start properly.

SETTING THE DRAFT (6500 Furnace)

A proper draft setting is crucial to the successful burning of solid fuels. Draft refers to the amount of air flowing through the burn chamber of your stove. Too much or too little draft will cause your furnace to burn improperly and may result in the fire burning out. Please follow these guidelines carefully as you operate your furnace to achieve maximum efficiency and value..

- ✓ The amount of draft required for your furnace to burn properly will depend upon your installation and the fuel you use. You can set your draft by looking at the flame and following these guidelines. The manual draft lever is the rod and knob on the back right side of the unit. Turning the lever toward a vertical position increases the draft and turning the lever toward a horizontal position decreases the draft. A little movement of the lever goes a long way to changing the flame. It may take several trial and error adjustments on the draft to achieve the correct setting.
- ✓ The flame should be an “active” flame. A flame that moves around lazily and emits visible smoke needs more draft. To give the fire more draft, turn the lever counter-clockwise 1/8” and check the flame again. If the status of the flame has not changed, move the lever another 1/8” until you get a clean “dancing” flame. **If moving the damper does not change the fire, you might have negative pressure in the home. Consult with your Magnum installer.**
- ✓ The base of the flame should be blue in color and the top of the flame should be yellow.
- ✓ If the flame does not have enough draft, fuel will build up in the firepot and eventually smother the flame. If this happens, or if you notice the firepot is filling up with partially burned fuel, open the damper 1/8” at a time until the fire is clean and dancing.
- ✓ If the flame has too much draft, the flame will look like a torch in that it will be moving rapidly and blowing fuel out of the firepot. If you find that you have this condition, move the damper counter clockwise 1/8” at a time until the condition of the flame changes.

When you change fuel sources it may become necessary to readjust the damper control knob. You should not have to continually adjust the manual knob except when using the high fuel setting. The circuit board automatically adjusts the air to the firepot on the settings from 1 to 3.

MAINTENANCE INSTRUCTIONS

DAILY MAINTENANCE

- ✓ **Surfaces on the front of the furnace will be extremely hot during operation.** Always wear heat resistant gloves to perform periodic maintenance.
- ✓ Grab the brass knob to move the heat exchanger rod in and out. Do this several times and return it to operating position, all the way in. **This should be performed approximately every 24 hrs.**

- ✓ Using the clean-out tool, tap the side heat exchangers that are located on the left and right sides of the firebox. When you open the door, they are located directly inside to the left and right. When you tap the sides with the clean-out tool the loose fly ash will drop out of the sides to the bottom of the burn area. **This needs to be done once a week.**

Left side heat exchanger shown. Some models of 6500/7500 furnaces do not have the cleanout plugs.



- ✓ While you are tapping the side heat exchangers, we recommend that you turn the draft lever all the way open for a minute or two and put the unit on high fire. This will allow the unit to self-clean the heat exchanger area, the draft fan and exhaust chimney pipe.
- ✓ If a clinker ball develops in the firepot, scrape it out with the clean-out. You may have to do this once or twice a day depending on the moisture content of the corn. If this is not cleaned out, it could cause the fuel stirrer to jam. Clinker balls are a direct result of excessive corn moisture and they do not indicate a problem with the stove. AES highly recommends our additive called “Clean Burn” be added to your corn to eliminate these clinkers. Contact your local **Magnum** reseller for availability and cost. Clean burn is not normally needed for the model 6500 furnace.

- ✓ Open the stove doors and wipe the inside of the glass with a damp cloth as needed.

- ✓ The ash pan needs to be checked daily to make sure that the ash has not built up to the bottom of the firepot area. **DISPOSAL OF ASHES:** Ashes must be placed in a metal container with a tight fitting lid. The closed container can only be placed on a non-combustible surface well away from any combustible material. If the ashes are not disposed of by burial in soil or otherwise dispersed, they need to be retained in the closed container until all ashes have thoroughly cooled.

- ✓ Make sure that the ash pan latches are tightened all of the way. Once ash pan has been replaced.

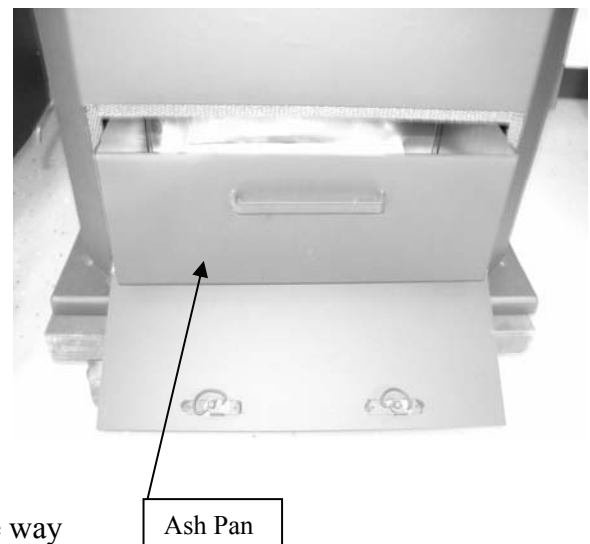

SPECIAL CLEANING/OPERATIONAL/INSTALLATION INSTRUCTIONS:

CREOSOTE – FORMATION AND NEED FOR REMOVAL: With the low operating temperatures of the Magnum furnace and if the venting is on an exterior installation, creosote may form. Creosote is a tar-like substance combined with other organic vapors, which combine with expelled moisture to form creosote. The creosote vapors condense in the relatively cool venting. As a result, creosote residue accumulates on the venting lining. When ignited this creosote makes an extremely hot fire. Inspect the venting at least twice monthly during the heating season to determine if a creosote buildup has occurred. If creosote has accumulated it should be removed to reduce the risk of a venting fire.

It is important to establish a routine for the storage of fuel, care of the appliance, and firing techniques. Check daily for creosote buildup until experience shows how often cleaning will need to be performed. The hotter the heat setting on the furnace the less creosote is deposited so it will take more frequent cleaning in mild weather than in cold weather when the heat settings are higher. A mid range heat setting is more acceptable than a low setting to reduce the amount of creosote buildup.

It is very important to have a clearly understood plan to handle a venting and/or hopper fire. It is highly recommended to have the fire department and police department numbers close by.

On the model 7500 furnace you need to make sure that the clean-out plates are in the closed position. Push the front (2) clean-out slides all the way in and make sure that you have replaced the left & right clean-out plates that are located on the inside of the unit. (These plates are located inside the firebox to the left and right of the firepot in the lower corners of the firebox.) If these plates are not in the closed position the unit will burn dirty. The ash pan door needs to be locked in place after emptying. If the door is left open improper air circulation will occur and the furnace will burn dirty. The door opens by turning both doorknobs as far to the left as possible. To seal tight they need to be turned right as far as possible.

WARNING: Risk of Fire

DO NOT OPERATE WITH FUEL LOADING OR ASH REMOVAL DOORS OPEN

Maintain the seals on the door, ash pan door and hopper lid to keep a tight seal.

INSPECT AND CLEAN VENTING REGULARLY

CAUTION: Hot Surfaces

CAUTION: INSPECT VENTING PIPES, JOINTS AND SEALS REGULARLY TO ENSURE THAT SMOKE AND VENTING GASES ARE NOT DRAWN INTO, AND CIRCULATED BY THE AIR-CIRCULATION SYSTEM.

Keep Children away from the furnace at all times

Do not touch front of unit or hot surfaces during operation

Do not take out the Combustion Enhancement System without the tool provided and leather Gloves

The furnace has a heat exchanger tube cleaning rod to clean once a day. Excessive ash on the exchanger will cause diminished heat output.

The Magnum 7500 furnace has (2) front cleanout slides that must be in the closed position when burning the unit. The 6500 does not have these.

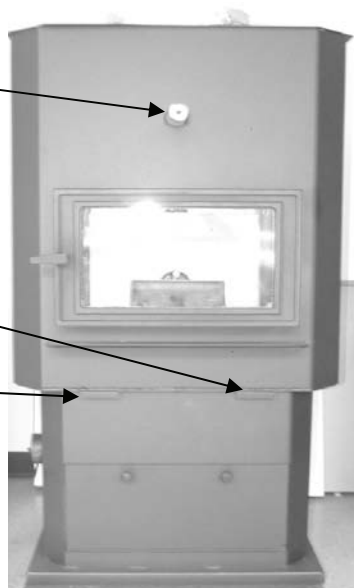

The furnace has clean-out plates located inside the door in the lower left and right corners of the firebox. Shown with plates remove. The 6500 does not have these.

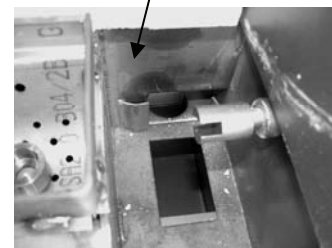

WEEKLY MAINTENANCE

- ✓ Set the furnace on high fire. Open the draft to 100% and allow the furnace to burn for 15 minutes. Resume desired heat and draft setting. Make sure to monitor your fire during this time to make sure that the additional draft does not put your fire out. **If fuel moisture is high, do this once a day.**
- ✓ Shut down the furnace as directed in the operating instructions. Allow the furnace to cool to room temperature. Remove the small clean-out slides in the lower corners of the firebox. Tap the sides of the burn chamber with the clean-out tool. Do not tap the firewall behind the burn box as it may damage the insulation. Using the clean-out tool, scrape the fly ash from the clean-out chambers toward the front of the burn chamber. Remove the fly ash from the burn chamber and replace the clean out chamber doors.
- ✓ Remove the ash pan and dump the ash into a metal container. See instructions on daily maintenance.
- ✓ 7500, remove the firepot by stopping the fuel stirrer in the upright position, slide the collar off of the fuel stirrer coupler shaft and pull up and out on the firepot. Using the clean-out tool, remove any ash that might have built up in the system or air intake. Remove your brick board when the fire pot is removed. Inspect the rear air chambers (remove the cleanout plugs) and clean if necessary. If this area plugs with ash improper air flow will occur and cause the furnace to burn dirty or shut it down.
- ✓ Cleaning of the exhaust system will depend upon the ash and debris content of your fuel. If your fuel has a high ash content and/or significant debris in it, your exhaust system will require weekly cleaning. Cleaner fuels will allow for monthly cleaning of the exhaust system. Remove the exhaust pipe from the back of your stove and remove any ash that may have collected in the pipes. Replace the pipes to the stove and seal with high temperature seal tape. If you have installed proper clean out tees you will not have to take the chimney sections apart.
- ✓ While you are doing your weekly cleaning, have the unit set on high and the draft lever turned all the way open. Remember the unit is not burning. After cleaning, turn the draft lever back to its normal position.
- ✓ **IMPORTANT: If you remove the cleanout plugs (2" diameter cleanout ports with plugs in them) that are located behind the brick board, on the exhaust manifold and on some models the left and right heat exchanger plates, be sure to re-install them. If they keep falling out replace them with new ones. Do not operate the unit without them installed. If you are having trouble contact your local service technician for help.**

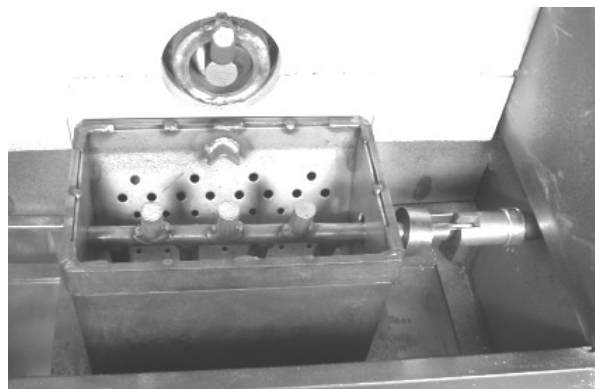

REMEMBER: A clean unit burns efficiently and will remain trouble free!

Monthly: Check the furnace filter and replace if dirty. The filter can be pulled out either side of the furnace. WARNING: a dirty filter can cause serious damage to the furnace and the heating ability will be reduced.

SPRING CLEANING:

When the heating season is over make sure that you clean out all of the fuel in the hopper, firebox area, ash pan and firepot area. Corn can accumulate moisture over the summer months causing the unit to rust and the fuel to mold.

It is recommended that prior to shutting down the unit in the spring, run the unit on the higher settings for a day to help clean out the heat exchanger system, venting system and firebox area.

When the unit is cleaned out, take the venting apart, clean out the fly-ash, rinse the venting out with a water hose and let dry, take the draft blower off and clean, clean out all areas such as back heat exchanger and lubricate the auger, auger tube, firepot area, fuel stirrer shaft and bearings and hopper area with a light oil. (Something like Pam cooking oil works great to coat the inside of the unit and the moving parts.

Clean the glass, doors and outer cabinet so that you are ready for the next heating season.

AUTOMATIC SAFETY FEATURES

WARNING

These automatic safety features must not be bypassed.

✓ **Power Outage**

During a power outage, the furnace will shut down safely. It will not automatically restart when the power returns, unless the exhaust is still up to temperature (see “Lighting Instructions”).

✓ **Overheating**

A high temperature fan limit switch will automatically shut down the furnace if it overheats. The furnace will need to be manually re-lit. Allow 45 minutes before re-lighting.

The circuit board is equipped with a 5 amp. Fast acting fuse. If the unit does not operate and there is power coming into the unit, check and replace the fuse. Always replace with a fast acting fuse.

The Magnum 7500 is equipped with a fan limit control system that is installed 10” above the top of the unit. This fan limit control must be operational and not set on manual fan operation. The fan limit control will turn the room air blower on and off with the correct temperature and will shut the fuel feed off if the unit overheats or there is an obstruction in the duct work. The Magnum 6500 model has the fan limit and high limit controls located inside of the unit on the left side.

IMPORTANT: Make sure that the power source conforms to the requirements of the furnace. It is highly recommended that you run a separate circuit to assure constant power. A 15 amp circuit is needed. Disconnect the power source before performing any maintenance or electrical service work.

Plug the power supply cord into a surge protected and grounded 15-amp branch circuit. The outlet must be checked for correct polarity. Check the outlet for a minimum 115 volts and that the branch circuit is not overloaded with too many appliances hooked to it. Run a separate circuit if it is overloaded.

THERMOSTAT INSTALLATION

- ✓ The **Magnum 6500/7500** can be installed with and operated by a wall-mounted thermostat. However, a wall thermostat is not provided with the furnace. A wall thermostat can be purchased from your reseller or at most home improvement centers or hardware stores. We recommend the Honeywell model T87F or equivalent low voltage thermostat
- ✓ Most thermostats will have instructions with them as to where to place them in your room. Please follow the thermostat manufacturer's instructions carefully. Use thermostat wire (18/2).
- ✓ There are two (2) male spade terminals on the back of the control panel near the center. Connect the two wires from the wall thermostat, one to each of these spade terminals. **Needed: 2 female 1/4"** insulated terminals.
- ✓ Make sure that the wires are routed to protect them from hot surfaces. Do not cross wires with circuitry on board.
- ✓ The circuit board is located on the left side of the unit. Remove the 1/4" hex head screw and pull circuit board towards you. Lift the circuit board out of the housing. Do not crimp or stretch the wires leading from circuit board pigtail. **(Unplug the power cord before working on unit)**
- ✓ Reinstall in reverse procedure.

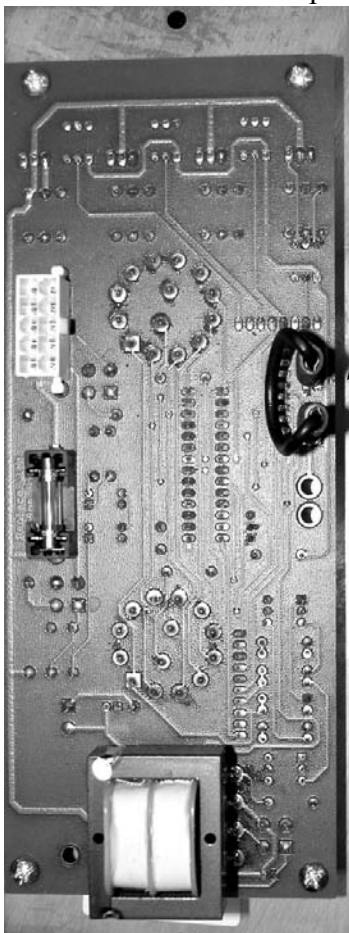

Two (2) 1/4" male spade connectors, one for each wire from wall thermostat

Operating the furnace with a wall thermostat takes a little experience to get used to. Heat levels from 2-3 work very well with the wall thermostat but the heat level 4 or high may require manual air adjustments. Consult with your dealer to get recommended settings and advice.

It is a good idea to use the thermostat option to achieve uniform control over your heating needs. By setting the unit on a number 3 setting (this is the normal setting but can be any setting from 2-high) for high fire and letting the wall thermostat control it, the fire will drop down into a pilot fire after the home reaches the desired temperature.

If you are gone and the home requires heat, the unit will automatically resume the high setting when the thermostat calls for heat

Magnum 7500 Wiring Diagram

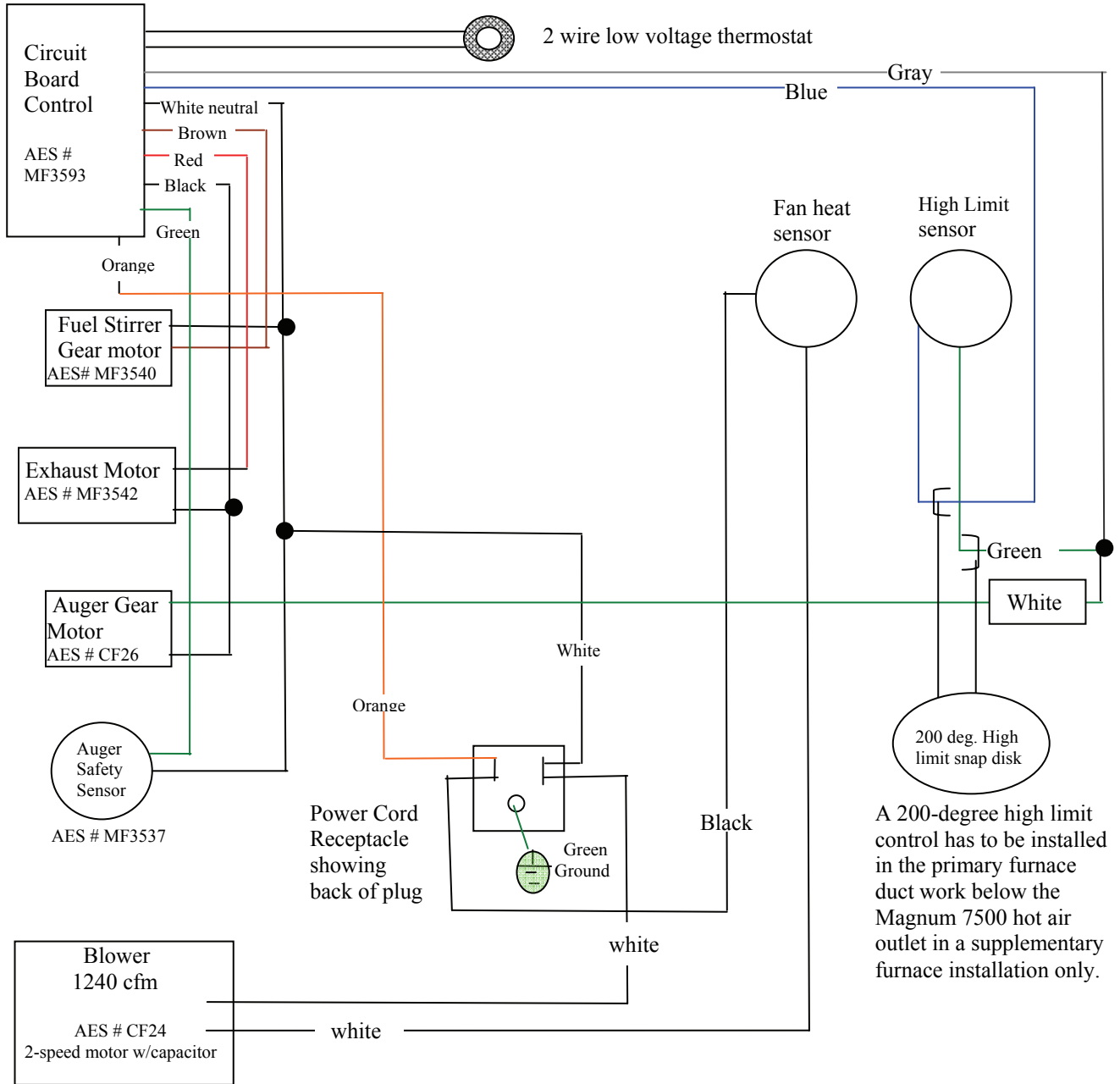

A 200-degree high limit control has to be installed in the primary furnace duct work below the Magnum 7500 hot air outlet in a supplementary furnace installation only.

The High limit control is pre-set and does not need to be adjusted. If the furnace is overheating consult your HVAC installer for proper duct installation, pressures and sizing.

The fan limit control heat settings are pre-set and do not need to be changed. If the room fan is cycling often consult your HVAC contractor for proper duct pressure setting.

Magnum 6500 Wiring Diagram

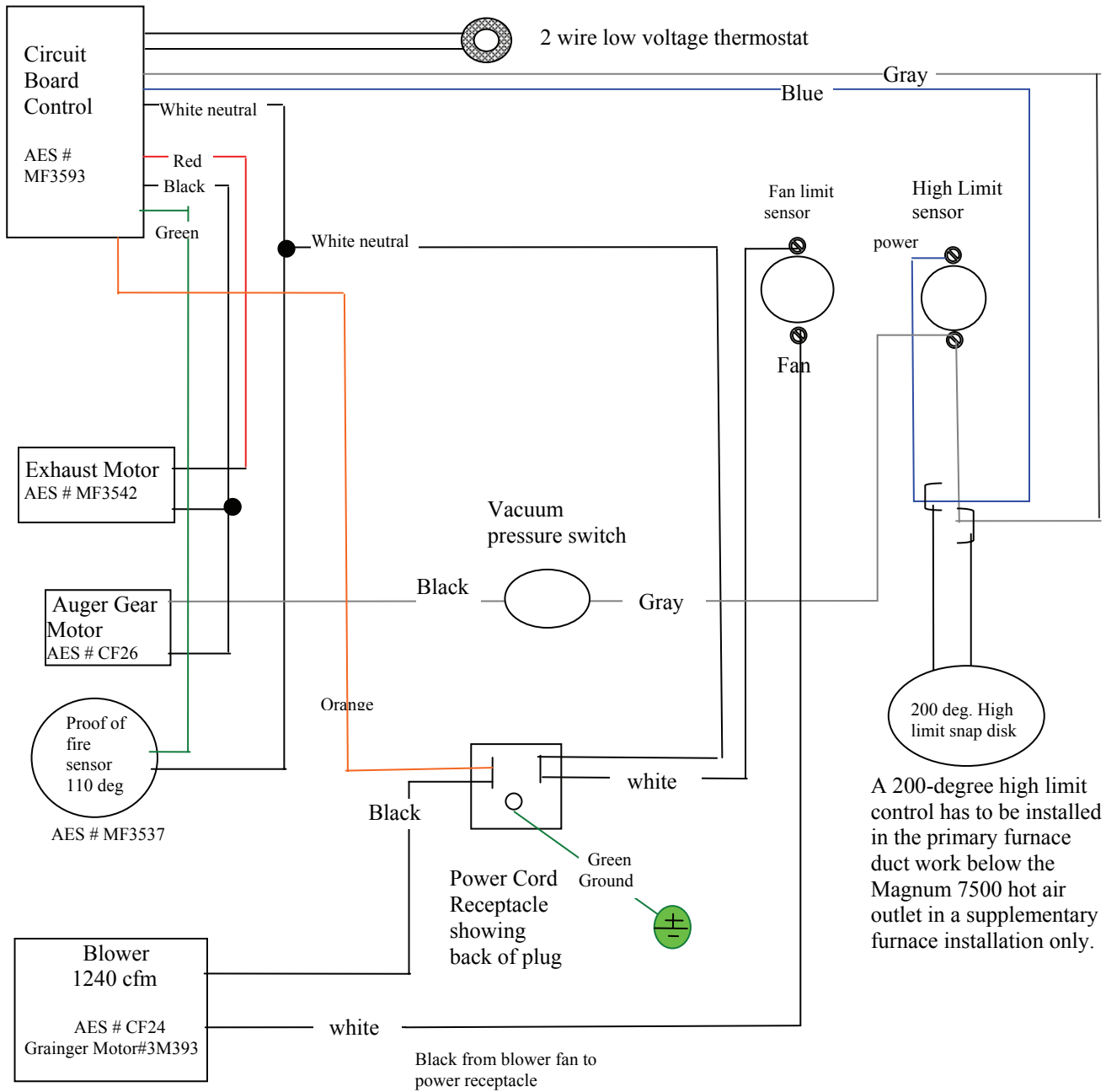

A 200-degree high limit control has to be installed in the primary furnace duct work below the Magnum 7500 hot air outlet in a supplementary furnace installation only.

The High limit control is pre-set and does not need to be adjusted. If the furnace is overheating consult your HVAC installer for proper duct installation, pressures and sizing.

The fan limit control heat settings are pre-set and do not need to be changed. If the room fan is cycling often consult your HVAC contractor for proper duct pressure setting.

TROUBLE SHOOTING GUIDE

Unplug stove before performing any maintenance work. Do not work on unit when it is hot.

| PROBLEM | CAUSES | SOLUTIONS |
|--|--|---|
| <p>? Fire burns with a lazy, orange flame and/or fuel builds up in the firepot and excessive (builds up in a hour or so) soot gets on the window.</p> | <ul style="list-style-type: none"> ◆ Insufficient combustion air. ◆ Feed rate too high. ◆ Corn or wood pellets have too much moisture – need 14% or less; 10%-12% is ideal. ◆ Combustion/Exhaust blower plugged or going out ◆ Venting plugged with fly ash or ice. ◆ House does not have adequate make up air (negative pressure) | <ul style="list-style-type: none"> ✓ Remove any clinkers or ash from the firepot by using scraping tool. Shake ashes into ash pan. ✓ Clean out primary air in firepot holes if plugged. ✓ Empty ash drawer and clean out back heat exchanger by removing the lower access plates. ✓ Tap the side exhaust heat exchangers to clean them as shown. ✓ Change to a better grade of fuel if necessary. ✓ Check that damper control knob is adjusted properly. Turn the manual air knob open until desired burn is achieved. ✓ Check gasket seal around the door. If the door is loose, adjust the handle latch. A small adjustment can be made to the door seal by adjusting the door latch rod and /or the door hinges. Replace the door gasket if necessary. ✓ Check for blockage in the air inlet tube or exhaust pipe. Clean out as necessary. ✓ Check combustion exhaust blower impeller. This can be done by removing the exhaust pipe and shining a light into the tube or remove inspection cap on exhaust manifold. ✓ Replace combustion exhaust blower if necessary. <p>NOTE: Negative pressure in a home is a serious issue. All Magnum furnaces need to be installed with outside air. If the home has severe pressure problems the furnace could become the house air conduit causing major operation problems</p> |

| PROBLEM | CAUSES | SOLUTIONS |
|--|--|--|
| <p>? Fire goes out or stove shuts down automatically.</p> | <ul style="list-style-type: none"> ◆ Hopper is empty. ◆ Fuel is not feeding. ◆ High limit temperature switch has tripped. <p style="margin-left: 20px;">Too much air to firepot.</p> <p style="margin-left: 20px;">Fuel feed high or low.</p> ◆ Hot air vents are closed ◆ Dirty filter | <ul style="list-style-type: none"> ✓ Refill hopper. ✓ See “Pellets will not feed” below. ✓ Allow furnace to cool for 1 hour and relight. Check your furnace filter to make sure that enough air is passing through the system. Clean or replace if dirty. Do not restrict panel vents on furnace. ✓ Adjust the damper to reduce combustion airflow. ✓ Have your Magnum reseller adjust the fuel control. <p style="margin-left: 20px;">Open all registers. Too much heat in supply lines has caused in line sensor to shut system down. Make sure filter is clean to let enough air pass thru system.</p> |
| <p>? Fuel will not feed.</p> | <ul style="list-style-type: none"> ◆ Hopper is empty. ◆ Auger, circuit board, high limit switch tripped ◆ A foreign object is caught in auger ◆ Fuel is dirty and or wet ◆ Auger motor is bad or loosened | <ul style="list-style-type: none"> ✓ Check contents of the hopper. Add fuel if necessary. ✓ Have your Magnum reseller diagnose the problem and replace the parts. |
| <p>? Furnace runs for 30 minutes and then shuts down.</p> | <ul style="list-style-type: none"> ◆ Exhaust gas is not up to temperature. Started on too low of Setting. <p style="margin-left: 20px;">Low limit snap switch not operating correctly; may be defective.</p> ◆ Wires to either the low limit snap switch (mounted on the side of the firebox or exhaust manifold) are loose or disconnected. | <ul style="list-style-type: none"> ✓ Relight the furnace. Start on higher setting ✓ Have your Magnum reseller replace the low limit switch. ✓ Contact your local Magnum reseller for service. |
| <p>? Blower will not shut off after the fuel has been switched off and the stove has cooled down.</p> | <ul style="list-style-type: none"> ◆ Fan Limit switch has failed in the closed position. ◆ Unit has not cooled down yet. ◆ Fan Limit switch has stuck | <ul style="list-style-type: none"> ✓ Have your Magnum reseller replace the Fan Limit control. ✓ It can take up to 1 hour for the unit to cool down enough for the blower to shut off. If it takes longer than 2 hours for the blower to shut off or if it fails to shut off contact your local Magnum service technician. <p style="margin-left: 20px;">Tapping on the switch will free up a sticky switch. Make sure electrical is unplugged</p> |

The leading reason that the appliance shuts down, will not produce heat or runs erratically is because the venting, fresh air or ducting system was not installed properly. If the ducting system is correct, the venting system balanced and the fuel is clean and dry, the furnace will operate as designed.

| PROBLEM | CAUSES | SOLUTIONS |
|--|--|---|
| <p>? Blower will not operate.</p> | <ul style="list-style-type: none"> ◆ No power to stove. ◆ Blower is defective ◆ Ductwork is inadequate and is overheating the blower motor | <ul style="list-style-type: none"> ✓ Check to see that the stove is plugged into the wall outlet. ✓ Check to see if your circuit breaker has “tripped”. ✓ Check wire connections to make sure that all are connected. ✓ Have dealer replace blower motor ✓ Correct the duct work |
| <p>? Soot or fly ash in the house.</p> | <ul style="list-style-type: none"> ◆ Cleaning the window, particularly when the stove is operating. ◆ Leakage on the joints between the combustion fan, exhaust pipe and “PL” vent. This will be evidenced by dust on the impeller of the convection fan and in the heat exchanger tubes. ◆ Using a conventional vacuum for cleaning. Ash will bypass. ◆ Negative pressure in home is sucking the ash out of the unit through the door when cleaning, etc. | <ul style="list-style-type: none"> ✓ Clean the glass when the unit is not running ✓ Seal any leaks in the exhaust system with RTV high temperature silicone sealer. ✓ Use an approved ash vacuum system. ✓ Have the home checked for negative pressure and proper installation of ductwork, etc. |
| <p>? Buildup of soot on glass, venting and heat exchangers</p> | <ul style="list-style-type: none"> ◆ Dirty fuel ◆ Wet Corn (above 15% moisture) ◆ Inadequate air supply ◆ Negative pressure in home | <ul style="list-style-type: none"> ✓ Make sure you have clean fuel ✓ Dry the corn down to 11-12% moisture if possible or mix with wood pellets ✓ Turn manual draft control open slightly to make sure that there is app. ½ inch of fuel in firepot ✓ Install outside air to unit and make sure that the home has adequate make-up air. (suggested 8” make-up air into basement) |
| <p>Fuel Stirrer keeps jamming or breaking</p> | <p>Buildup in the firepot Dirty, Wet fuel Poor fuel quality</p> | <ul style="list-style-type: none"> ✓ Add Clean Burn additive ✓ Clean and dry fuel. Try a different fuel source. |
| | | |

CAUTION: When performing any internal electrical maintenance

- Moving parts inside of the cabinet may cause injury. Do not operate unit with panels removed or open.
- HOT parts. Do not operate the unit with panel open.
- Risk of electrical shock. Disconnect power before servicing unit.
- In the event of component failure, replace with original factory equipment.

| PROBLEM | CAUSES | SOLUTIONS |
|---|---|---|
| Fuel burns off to quickly, have difficulty keeping a pilot fire. | <p>Air shutter is open to far.</p> <p>Over drafting on a vertical install.</p> <p>Outside air is not hooked up</p> <p>Positive or negative pressure in home is affecting the furnace operation</p> <p>The cold air return is not hooked up or is drawing from inside the furnace room</p> | <p>Adjust your air shutter to a more closed position.</p> <p>A chimney restrictor may need to be installed. Consult with your Magnum dealer.</p> <p>Make sure that the installation is correct and nothing is affecting the furnace room</p> |
| Foreign object caught in the auger and will not turn. | Accidental object in fuel. | <p>If there still is a fire, let it extinguish and let furnace cool down. Unplug furnace after furnace has exhausted. It will be necessary to clean out hopper. As you are facing the furnace open the right hand side panel. The auger motor will have a small cooling fan on the back. Turn the fan counter clockwise until tension is off the auger. Open the front door of the furnace and pull the auger out. Prying on the auger without loosening first can damage auger gear box.</p> |
| Getting to much ash. | <p>Dirty fuel</p> <p>Wet fuel</p> <p>Lack of clean combustion air.</p> <p>Dirty or plugged stove or venting. Poor exhaust vent configuration.</p> <p>Negative pressure present in the home</p> <p>Combustion motor going out.</p> <p>Use combustion enhancement system</p> | <p>Adequately screen corn. Dirty , wet fuel will produce excessive ash</p> <p>Take proper steps to check corn for proper moisture and to adequately protect from the elements to not take on moisture.</p> <p>Check damper control and check combustion air inlet for obstructions.</p> <p>Check all cleanouts and exhaust venting for obstructions. Refer to cleaning section of this manual.</p> <p>Call your Magnum reseller to inspect installation and operation. Replace any bad parts.</p> <p>On higher heat settings combustion enhancement system will keep ash volume down.</p> |
| The heat output is not as high as when the furnace was installed. | <p>Wet or dirty fuel.</p> <p>Inadequate cleaning.</p> <p>Dirty room air filter.</p> <p>Change of fuel to lower BTU value</p> <p>Negative pressure or improper ductwork is causing unit to perform improperly</p> | <p>Wet fuel has a much lower BTU output. The furnace requires 14% or lower moisture corn. Dirty fuel does not produce adequate heat. Excessive amounts of fines interrupt the amount of corn delivered for burning and will decrease heat output.</p> <p>Clean heat exchangers daily, tap side exchangers, inspect furnace for air flow. Clean or replace filter.</p> <p>Have dealer check for proper installation and negative pressure in home.</p> |

IMPORTANT: Electrical work must be performed by an authorized technician.

WARNING: This section is only for qualified technicians.

SETTING THE CIRCUIT BOARD (fuel stirrer option is not used on the 6500 furnace)

If the low fire heat setting is too low for the fuel that you are burning and the fire goes out, the number 1 or 2 heat setting can be adjusted through the access hole located next to the system indicator light. (2)

If the draft setting is too low on the number 1 or 2-heat setting, it can be adjusted through the access hole located next to the fuel stirrer knob. (1)

To adjust the settings, place a small screwdriver through the hole to the adjustment screws. Turning the screw clockwise increases the draft and counterclockwise decreases the draft. (1) Turning the screw clockwise increases the fuel feed rate and counterclockwise decreases the fuel feed rate. (2)

The systems indicator light will blink showing the number that you are on. There are 10 settings that are available with 1 blink being the lowest and 10 blinks being the highest. When you turn the adjustment screw to the next setting the light will blink the number that you are on and then the light will stay on. (Example: If the setting is turned to # 9 the light will blink 9 times and then stay on).

Draft Adjustment

Note: Number 1 on the draft adjustment setting is the lowest setting and on the Fuel Feed rate adjustment setting it is the lowest feed rate. As you turn the adjustment screw clockwise 1 – 2 – 3, etc the draft (1) will increase and the fuel feed rate (2) will increase.

The normal settings on both should be 1 blink

THESE SETTINGS NEED TO BE MADE BY A QUALIFIED MAGNUM SERVICE TECHNICIAN.

The circuit board fuse is located on the back of the board. If the board does not work, check the fuse to make sure that it is good.

The thermostat hookup is located on the back of the circuit board. See thermostat installation.

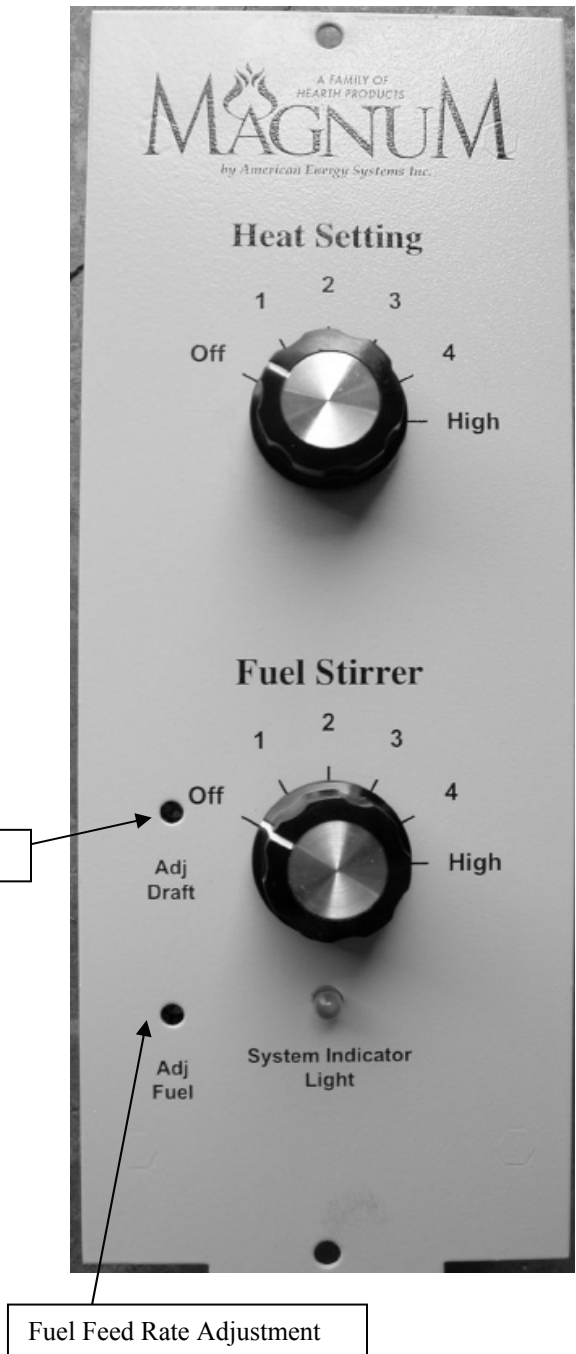

DRAFT SLIDE GATE ADJUSTMENT

(Optional equipment)

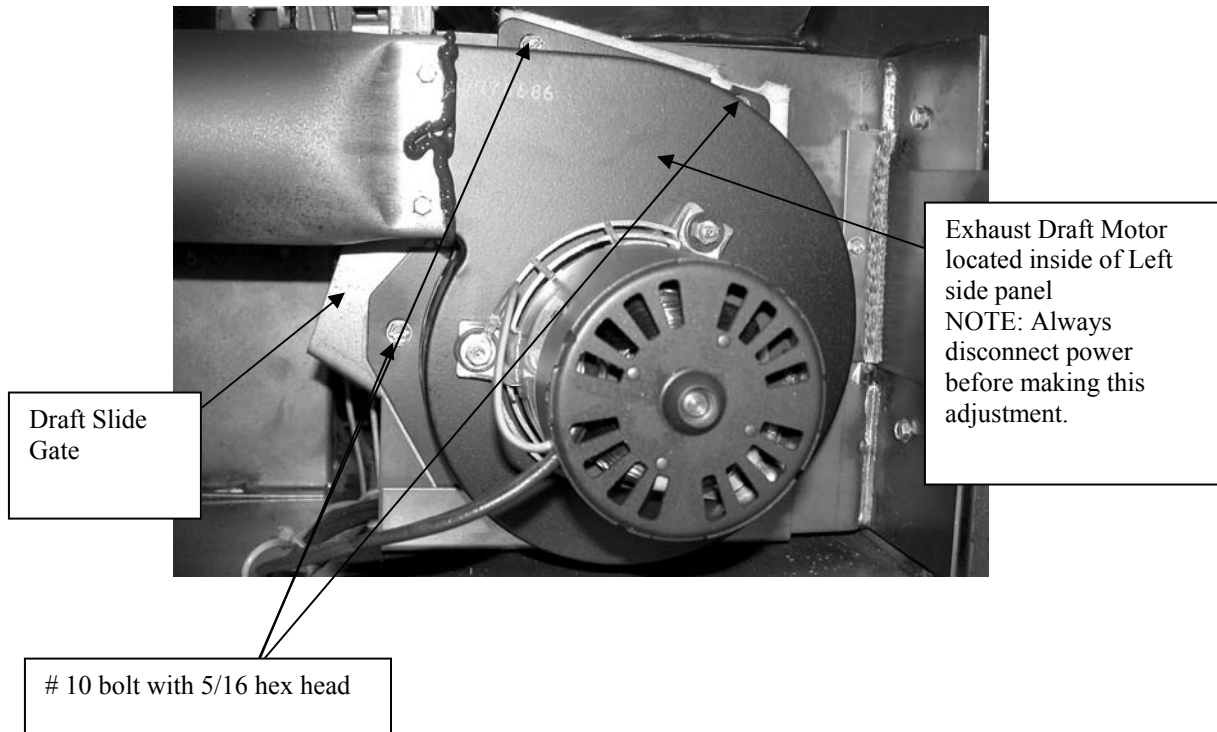

The normal operation of the Magnum would be with the Draft Slide Gate open fully as shown. When the gate is in the fully open position, the plate will be against the mounting plate as shown. If the unit needs a draft correction adjustment, the bolts are loosened and the slide gate is rotated a few degrees at a time until the proper operation of the unit is achieved.

NOTE: This adjustment must be made by a qualified Magnum installer

When rotating the slide gate, be careful not to damage the gasket. Re-tighten the bolts and check for leaks.

If your furnace burns with a lazy flame or does not appear to get enough draft, the draft gate is closed too far. This adjustment should only be made if the furnace does not stay lit on the number one heat setting and it has been determined that the installation, fuel, venting and operation of the unit is not causing the problem.

When the unit is installed, make sure that the draft gate has not slid partially closed and is not loose.

| ORDER # | DESCRIPTION |
|----------|--|
| AFP24 | Spring Handle, Gold, Heat Exchanger Rod |
| CF02 | Ash Pan Assembly, Magnum 7500 |
| CF06 | Firepot, Stainless Steel, Corn/Biomass, 7500 |
| CF13 | Door, Black, 6500 & 7500, Countryside (when purchased separate from unit) |
| CF22 | Filter, Cold Air Return, Magnum 6500 & 7500 |
| CF23 | Fan Limit Control, Magnum 7500 furnace 2004 or earlier, 2E232 (control only, wiring harness sold separate) |
| CF25 | Blower/Fan, Room, Complete Assembly (when purchased separate from unit) |
| CF26 | Motor, Auger Feed Gear, 8 rpm (Magnum 7500 only) |
| CF27 | Combustion Enhancement System |
| CF33 | Motor, Furnace Blower, ¼ hp single speed (3M393) 2004 and older Magnum 7500 (formerly part CF24) |
| CF35 | Mount, Motor, New Auger Motor, Retro-Fit Kit (7500 furnace 2003 or earlier) not for new units |
| CF37 | Scraper Assembly, Firepot, 6500 |
| CF38 | Firepot, Steel Corn/Biomass, 6500 |
| CF40 | Ash Pan Assembly, Magnum 6500 |
| CF3515 | Door, 24K Gold, 6500, & 7500, Countryside (when purchased separate from unit) |
| CF3519 | Door, Nickel, 6500 & 7500, Countryside (when purchased separate from unit) |
| CF3542 | Draft/Exhaust, High Altitude Output Blowers, Magnum 6500 |
| MF3511 | Bushing, Bronze (fuel stirrer shaft bearing) 2 pcs. (7500 & all countryside models) |
| MF3513S | Fuel Stirrer, Welded, Stainless Steel, 7500 |
| MF3514 | Drive Shaft Assembly, Fuel Stirrer, 7500 (includes P003088 ½" ID collar) |
| MF3516 | Chain, Fuel Stirrer, 7500 |
| MF3517 | Sprocket, Fuel Stirrer, 11-tooth sprocket on motor, 3/8" Diameter shaft, 7500 |
| MF3518 | Sprocket, Fuel Stirrer, 11-tooth sprocket on shaft, ½" Diameter shaft, 7500 |
| MF3521 | Scraper Assembly, Firepot, 7500 (all product models except 6500) |
| MF3523 | Door Handle Assembly 7500, 6500, all Countryside models |
| MF3526 | Shoulder Bolt, with nut, ¼-20, Door Latch |
| MF3527 | Hinge, Door (each) takes two (2) per unit |
| MF3530 | Auger, 1 ½" Corn/ Wood Pellet/ Biomass, 7500 (3500P, 3500L, 3502 models) |
| MF3531 | Glass, Door (all models of Countryside & 7500, 6500 Corn Furnace) |
| MF3532F | Cord, Power, 7500 & 6500 furnace |
| MF3537 | Safety Sensor, Low limit/Fan, 110 deg. (located on Exhaust Manifold & upper air shell, left side) |
| MF3540 | Motor, Fuel Stirrer, Magnum 7500 & all Magnum Countryside models |
| MF3573 | Motor, Auger Feed Gear, 4+ rpm (Magnum 6500) Also used on Magnum Countryside models |
| MF3592 | Thermostat, Millivolt |
| MF3593 | Control Board, Magnum 7500 (current board used on Countryside) |
| MF3594 | Control Board, Magnum 6500 |
| MF3610 | Gasket, Exhaust Draft Motor (all models) |
| P6006 | Auger, 2" Corn/Wood Pellet / Biomass, 6500 |
| P7541 | Rod, Heat Exchanger, Magnum 7500 |
| P7554 | Brick board, 6500 & 7500B |
| P003015 | Slides, Clean Out, left or right front, Magnum 7500 |
| P003053 | Screw, Hex, #8 x ½" Tek ¼" |
| P003054 | Screw, Phillips, #10-32 x 3/8" |
| P003073 | Door, Clean-out, left or right lower back corners on Magnum 7500 Furnace |
| R-116NKL | Spring Handle, Nickel, Heat Exchanger Rod (when using Nickel plated door) |
| R0117 | Plug, Clean-out, 1 1/2" diameter knockout plug |
| RP2050 | Thermostat, Hi-Temp, Manual Reset, 225 Deg. 7500 & 6500 |

5 YEAR PRO-RATED LIMITED WARRANTY model 6500 & 7500 furnaces

This warranty is issued by American Energy Systems, Inc. (Manufacturer) and extends only to the original purchaser of this product. This limited warranty will not become effective unless you have returned the attached warranty card within 30 days of your purchase. If you fail to do so, you may make no claim under this warranty. American Energy Systems, Inc. excludes and disclaims all implied warranties including, but not limited to, the implied warranty of merchantability.

For a period of five (5) years from the original purchase, Manufacturer will warrant, to the original consumer-purchaser, that all steel components are free from defects in materials and workmanship pro-rated at 25% of retail price per year (except the firepot, which is covered by a one (1) year warranty and glass which carries a lifetime warranty against heat breakage). There is expressly no warranty on the fiberglass rope gasketing, insulation, brick board, log sets, fuel stirrer, paint, brass or gold plated surfaces, baffles or handles, rusting of surfaces, freight damage, rusting or plugging of heat exchanger tubes or back heat exchanger area, warping of firepot system.

The original manufacturer covers all electrical components, for a period of one year from the original purchase date.

If an electrical or structural item is replaced, the subsequent components are still warranted from the original purchase date of the appliance.

The warranty covers defects in materials and workmanship in covered components, provided the product has been installed and operated strictly in accordance with manufacturers printed instructions. This warranty does not cover damage or breakage due or caused by mishandling, wet fuel, foreign objects in auger system causing motor or auger to fail, rusting or corrosion of heat exchangers, firepot, freight damage, misuse or unauthorized modification of the structure or electrical system. Heat exchangers burning through are caused by poor fuel, improper installation operation or maintenance and will not be covered by this warranty.

This warranty will become null and void if furnace is not installed by a licensed HVAC contractor.

This warranty will become null and void if unauthorized fuel is used. Seed Corn and Wax Corn is prohibited.

Before exercising this warranty, a local representative (dealer) must inspect the unit to determine if the unit or installation is defective. If the inspection reveals that the failure is due to defective material or workmanship and the part is covered by the condition of this warranty, the Manufacturer will, at its option, repair or replace the defective part.

The sole duty of the Manufacturer and liability under this warranty is limited to the repair or replacement of the covered defective part. If the appliance has been installed incorrectly, the purchaser shall assume all liability and costs for repair/replacement. The purchaser shall assume all costs related to shipping the replacement parts or return of the unit to the factory for repair or replacement. If it is determined that the defect was caused by the Manufacturer, the Manufacturer will cover the costs (one way) of shipping the repaired unit or replacement parts to the original purchaser.

REMOVAL OR REINSTALLATION COSTS ARE NOT COVERED BY THIS WARRANTY.

Neither the Manufacturer, nor the Reseller to the purchaser, accepts responsibility, legal or otherwise, for incidental or consequential damage to property of persons resulting from the use of this product. Any warranty implied by law, including but not limited to implied warranties of merchantability or fitness, shall be limited to one year from the date of original purchase. Whether a claim is made against the Manufacturer based on a breach of this warranty or any other type of warranty, expressed or implied by law, Manufacturer shall in no event be liable for any special, indirect, consequential or other damages of any nature whatsoever in excess of the original purchase price of this product. All warranties by Manufacturer are set forth herein and no claim shall be made against Manufacturer on any oral warranty or representation.

THE MANUFACTURER WILL NOT BE LIABLE FOR ANY DAMAGE RESULTING FROM THIS APPLIANCE BEING INSTALLED BY A NON-LICENCED/NON FACTORY TRAINED HVAC INSTALLER

Some states do not allow the exclusion or limitation of consequential damages, or limitations of implied warranties, so the limitations or exclusions set forth in this warranty may not apply to you. This warranty gives you specific legal rights and you may also have other rights, which vary, from state to state.

Warranty/ replacement parts normally will be handled through the dealer that sold you your appliance. If your dealer is not providing this service you may contact the technical department at AES to receive instruction on how to file your claim to determine warranty. Do not take the appliance out of the installation until the factory has received proper documentation, pictures of installation, possible fuel samples and has given you an RMA #.

ALL CLAIMS UNDER THIS WARRANTY MUST BE MADE IN WRITING TO THE DEALER WHERE YOU PURCHASED THE APPLIANCE FROM or you may email technical@magnumheat.com.

All service records must accompany your claim along with pictures of installation, venting including termination, combustion air hookup including termination, front and back of unit, picture of installer tag on back of unit, picture of inside of hopper showing auger

If you are registering a claim against the dealership the following information must be included with the claim:

Name, address and telephone number of local dealer or representative.

Name, address and telephone number of the original purchaser.

Name, telephone number, HVAC contractor license number of certified installer.

Date of purchase along with the model and serial number of the unit.

Nature of defect and procedures of what has been done to correct the problem. **(unit must be inspected and documented by the dealer that sold you the unit before submitting a warranty claim.)**

